

The logo for TAI STAR, with 'TAI' in blue block letters and 'STAR' in red cursive script.

台斯達實業股份有限公司

射出機機械手配件

本公司已銷售國內外 21 年了，相容各大品牌機械手配件，如需詢價煩請聯絡

桃園龍潭

03-4705387 彭小姐、徐小姐

Line ID:0916398997

東莞長安

0769-5418440 李先生、徐先生

昆山玉山

0512-57371510 陳小姐、易先生



产品目录 PRODUCT INDEX

真空吸盘系列 P01

大头吸盘系列 P05

小头吸盘系列 P07

SMC 吸盘系列 P08

妙德吸盘系列 P13

星塔吸盘系列 P16

哈模、匹士克吸盘系列 P17

有信、条型吸盘系列 P19

海绵无痕吸盘系列 P22

金具系列 P01

天行大头、小头金具系列 P23

迷你金具系列 P42

抱具夹片系列 P45

夹具系列 P47

真空发生器系列 P52

治具零配件系列 P54

型号选定方法

真空用元件

1 真空吸着方式的特长

作为工件夹持方法的真空吸着，有以下特点：

- 构造简单
- 只要有可能吸着的面，即可对应
- 不需要定位
- 可对应柔软易变形的工件

但，必须要注意以下几点：

- 将工件吸着搬运，根据其条件的不同有落下的可能
- 会将工件周围的液体以及异物吸入
- 为了得到更大的加持力，有必要利用更大的吸着面积
- 有必要注意真空吸盘(橡胶)的劣化

上述特点充分理解后，根据使用条件使用。

2 真空吸盘的选定方法

● 真空吸盘的选定顺序

- 1) 充分考虑工件的平衡，明确吸着部位以及吸盘的个数以及吸盘的直径(或吸盘的面积)。
- 2) 由已知的吸着面积(吸盘的面积×个数)和真空压力。求的理论吸力。吸盘的实际吊力应考虑吸吊方法以及移动条件和安全率。
- 3) 工作的质量与吸吊力进行比较，为了要使吸吊力>工作质量，计算出必要且充分的吸盘直径(吸盘面积)。
- 4) 由使用环境以及工件的形状、材质，确认吸盘的形状、材质以及要不要缓冲器。

上述顺序表示的是一般的真空吸盘选定顺序，并非全部适用。最终结果根据客户的要求进行试验，并基于此结果，根据吸着条件决定使用吸盘。

● 真空吸盘选定时的要点

A. 理论吸力

- 理论吸吊力由真空压力以及真空吸盘的吸着面积决定。
- 理论吸吊力实在静的条件下得出的数值，实际使用的场合，还应根据使用状态，给予足够的余量以确保安全。
- 真空压力并不是越高越好，真空压力高时会发生异常情况。

- 当真空压力在必要以上时，吸盘的磨损量增加，容易引起龟裂，使吸盘寿命变短。
- 真空压力为2倍，理论吸吊力也为2倍，吸盘直径为2倍，理论吸吊力则为4倍。
- 真空压力(设定压力)设定过高，不但响应时间变长，发生真空必要的能量也会增大。

例) 理论吸吊力=压力 X 面积 2倍

吸盘直径	面积(cm ²)	真空压力 [40-kPa]	真空压力 [80-kPa]
∅20	3.14	理论吸吊压力 12.56N	理论吸吊压力 25.11N
∅40	12.56	理论吸吊压力 50.23N	理论吸吊压力 100.45N

4倍

B.关于真空吸盘的剪切力和力矩

- 真空吸盘的剪切力（吸着面和平行方向的力）与力矩都不强。
- 考虑工件的重心位置，时真空吸盘收到的力矩最小。
- 不但要使移动时的加速度尽可能小，还要充分考虑风压以及冲击力。如果在移动时的加速度缓和，则工件落下防止的安全性能就变高。
- 应尽量避免真空吸盘吸着工件垂直方向的面向上提升（垂直吊），不得已的情况下请考虑安全率。

吸吊力、力矩、水平力

上方吸吊的场合，不光要考虑工件的质量，还应考虑加速度、风压、冲击等等（参照图1）

为了不使吸盘的力矩变弱，安装时请不要让工件产生力矩（参照图2）

进行水平吸吊作业的场合，向横向移动时，会由加速度以及吸盘与工件间的摩擦系数的大小，使工件产生便宜。故请控制平移加速度（参照图3）

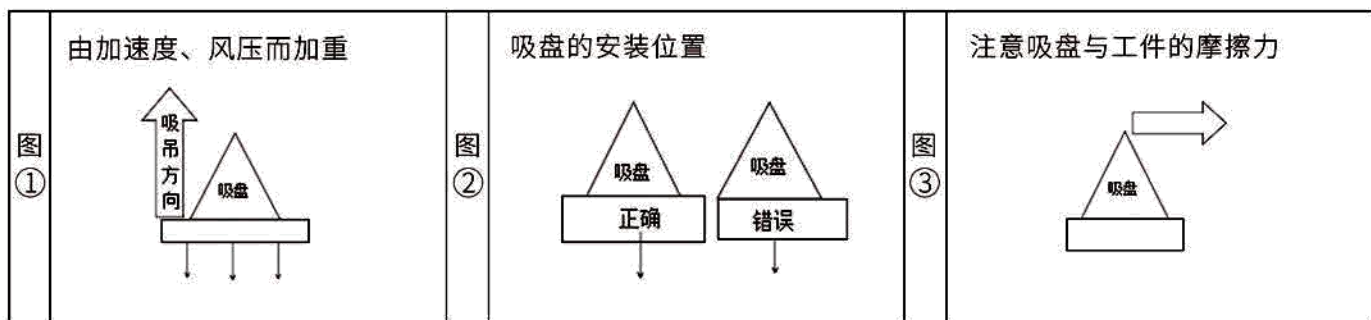

吸盘与工件的平衡

请不要使吸盘的吸着面积超过工件的表面。如果发生真空泄露，则吸着不稳。

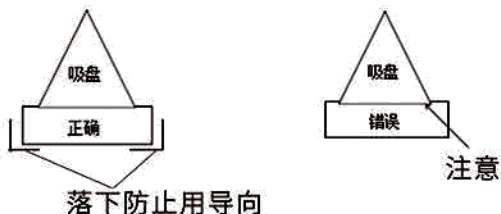

面积大的板材使用多个吸盘进行搬送的场合，要合理布置吸盘位置，增强吸吊平稳性。特别是周边部位，请确定好位置后进行配管。如有必要，请配置防止工件落下的辅助工具。

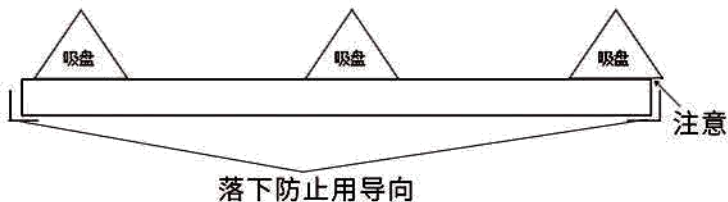

另外，如有必要，请配置防止工件落下的辅助工具(例：落下防止用导向)

安装方式

基本上水平安装，尽量避免倾斜以及垂直安装。不得已的情况下，使用导向以确保安全率。



● 求吸吊力和真空吸盘的直径

1) 求理论吸吊力

- 真空压力请设定在吸着稳定后的压力以下。
- 但工件有透气性的场合、工件表面粗糙度容易吸入空气的场合，必须考虑由于吸入大气，会使真空压力下降的因素，此类场合需根据进行的吸着测试来确定。
- 使用真空发生器的场合，真空压力大约为-60kPa左右。

吸盘的吸吊力，根据计算式以及下表1理论吸吊力表即可求出。

根据计算公式

$$W = P \times S \times 0.1 \times 1/t$$

W:吸吊力 (N)
 P:真空压力 (kPa)
 S:吸盘面积 (cm²)
 t:安全率 水平吊起: 4以上
 垂直吊起: 8以上

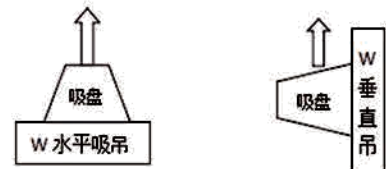

(从根本上, 请避免垂直吊)

根据理论吸吊力表

根据吸盘直径，真空压力，不含安全率可算出理论吸吊力。

理论吸吊力除以安全率t，可得出吸吊力。

吸吊力=理论吸吊力÷t。

1) 理论吸吊力表(理论吸吊力=P × S × 0.1)

吸盘尺寸 (Ø2—Ø50)

单位:N

吸盘尺寸(mm)	Ø2	Ø4	Ø6	Ø8	Ø10	Ø13	Ø16	Ø20	Ø25	Ø32	Ø40	Ø50
S吸盘尺寸的面积cm ²	0.03	0.13	0.28	0.50	0.79	1.33	2.01	3.14	4.91	8.04	12.6	19.6
真空压力 kPa	-85	0.27	1.07	2.40	4.27	6.67	11.3	17.1	26.7	41.7	68.3	107
	-80	0.25	1.00	2.26	4.02	6.28	10.6	16.1	25.1	39.3	64.3	101
	-75	0.24	0.94	2.12	3.77	5.89	10.0	15.1	23.6	36.8	60.3	95
	-70	0.22	0.88	1.98	3.52	5.50	9.3	14.1	22.0	34.3	56.3	88
	-65	0.20	0.82	1.84	3.27	5.10	8.6	13.1	20.4	31.9	52.2	82
	-60	0.19	0.75	1.70	3.01	4.71	8.0	12.1	18.8	29.4	48.2	76
	-55	0.17	0.69	1.55	2.76	4.32	7.3	11.1	17.3	27.0	44.2	69
	-50	0.16	0.63	1.41	2.51	3.93	6.7	10.0	15.7	24.5	40.2	63
	-45	0.14	0.57	1.27	2.26	3.53	6.0	9.0	14.1	22.1	36.2	57
-40	0.13	0.50	1.13	2.01	3.14	5.3	8.0	12.6	19.6	32.2	50	

吸盘尺寸 (Ø63—Ø340)

单位:N

吸盘尺寸(mm)	Ø63	Ø80	Ø100	Ø125	Ø150	Ø250	Ø300	Ø340
S吸盘尺寸的面积cm ²	31.2	50.2	78.5	122.7	176.6	490.6	706.5	907.5
真空压力 kPa	-85	265	427	667	1043	1501	4170	6005
	-80	250	402	628	982	1413	3925	5652
	-75	234	377	589	920	1325	3680	5299
	-70	218	351	550	859	1236	3434	4946
	-65	203	326	510	798	1148	3189	4592
	-60	187	301	471	736	1060	2944	4239
	-55	172	276	432	675	971	2698	3886
	-50	156	251	393	614	883	2453	3533
	-45	140	226	353	552	795	2208	3179
-40	125	201	314	491	706	1962	2826	

吸盘尺寸 (2X4~8X30)

单位:N

吸盘尺寸(mm)	2X4	3.5X7	4X10	5X10	6X10	4X20	5X20	6X20	8X20	4X30	5X30	6X30	8X30
S吸盘尺寸的面积cm ²	0.07	0.21	0.36	0.44	0.52	0.76	0.94	1.12	1.46	1.16	1.44	1.72	2.26
真空压力 kPa	-85	0.60	1.79	3.06	3.74	4.42	6.46	7.99	9.52	12.41	9.86	12.24	14.62
	-80	0.56	1.68	2.88	3.52	4.16	6.08	7.52	8.96	11.68	9.28	11.52	13.76
	-75	0.53	1.58	2.70	3.30	3.90	5.70	7.05	8.40	10.95	8.70	10.80	12.90
	-70	0.49	1.47	2.52	3.08	3.64	5.32	6.58	7.84	10.22	8.12	10.08	12.04
	-65	0.46	1.37	2.34	2.86	3.38	4.94	6.11	7.28	9.49	7.54	9.36	11.18
	-60	0.42	1.26	2.16	2.64	3.12	4.56	5.64	6.72	8.76	6.96	8.64	10.32
	-55	0.39	1.16	1.98	2.42	2.86	4.18	5.17	6.16	8.03	6.38	7.92	9.46
	-50	0.35	1.05	1.80	2.20	2.60	3.80	4.70	5.60	7.30	5.80	7.20	8.60
	-45	0.32	0.95	1.62	1.98	2.34	3.42	4.23	5.04	6.57	5.22	6.48	7.74
-40	0.28	0.84	1.44	1.76	2.08	3.04	3.76	4.48	5.84	4.64	5.76	6.88	

● 橡胶材质与特性

一般名	NRB (丁腈橡胶)	硅橡胶	聚氨酯橡胶	FKM (氟橡胶)	CR (氯丁橡胶)	EPR (乙丙橡胶)	导电性NRB(丁腈橡胶)	导电性硅橡胶	导电性硅橡胶海绵	导电性CR海绵 (氯丁海绵)	
主要特点	耐油性、耐磨耗性、耐老化性良。	耐热性与耐寒性优先	强度强度优先	最高的耐热性与耐化学性	拥有耐候性、耐臭氧性、耐化学品的性质。	耐老化性、耐臭氧性、电气的性质良。	耐油性、耐磨耗性、耐老化性良。具有导电性	高性的耐热与耐寒性优。具有导电性。	耐热性、回弹性优。	回弹性、隔音性优。有不易燃性	
纯橡胶的性质(比重)	1.00-1.20	0.95-0.98	1.00-1.30	1.80-1.82	1.15-1.25	0.86-0.87	1.00-1.20	0.95-0.98	0.4g/cm ³	0.161g/cm ³	
配合橡胶的物理性质	回弹性	○	⊗	⊗	△	⊗	○	○	⊗	×~△	×~△
	耐磨耗性	⊗	×~△	⊗	⊗	⊗	○	⊗	×~△	×	×
	撕裂阻抗	○	×~△	⊗	○	○	△	○	×~△	×	×
	耐弯曲龟裂性	○	△~○	⊗	○	○	○	○	×~○	×	×
	最高使用温度°C	120	200	60	250	150	150	100	200	180	120
	最低使用温度°C	0	-30	0	0	-40	-20	0	-10	-30	-20
	体积固有阻抗(Ωcm)	-	-	-	-	-	-	10 ⁴ 以下	10 ⁴ 以下	4.8×10 ⁴	3.8×10 ⁴
	热老化性	○	⊗	△	⊗	○	○	○	⊗	△	△
	耐候性	○	⊗	⊗	⊗	⊗	○	○	⊗	△	△
	耐臭氧性	△	⊗	⊗	⊗	○	⊗	△	⊗	△	△
耐气体透过性	○	×~△	×~△	×~△	○	×~△	○	×~△	×	×	
耐油性、耐油性	汽油、轻油	⊗	×~△	⊗	⊗	○	×	⊗	×~△	×	×
	苯、甲苯	×~△	×	×~△	⊗	×~△	×	×~△	×	×	×
	乙醇	⊗	⊗	△	△~⊗	⊗	⊗	⊗	⊗	△	△
	乙醚	×~△	×~△	×	×~△	×~△	○	×~△	×~△	×	×
	酮(MEK)	×	○	×	×	△~○	⊗	×	○	×	×
	醋酸乙基	×~△	△	×~△	×	×~△	⊗	×~△	△	×	×
耐碱性、耐酸	水	⊗	○	△	⊗	⊗	⊗	⊗	○	○	○
	有机酸	×~△	○	×	△~○	×~△	×	×~△	○	×	×
	高浓度有机酸	△~○	△	×	⊗	○	○	△~○	△	×	×
	低浓度有机酸	○	○	△	⊗	⊗	⊗	○	○	×	×
	强碱	○	⊗	×	○	⊗	⊗	○	⊗	△	△
弱碱	○	⊗	×	○	⊗	⊗	○	⊗	△	△	

◎=优...完全, 或几乎没有影响

○=良...有若干影响, 根据条件可充分使用

△=可...尽量不要使用

×=不可...有强烈的影响, 不适合使用

*记载的悟性, 耐化学性以及其它数值非保证值。

因使用环境的不用会有很大的出入, 本公司不作任何保证, 情充分调查确认使用。

● 橡胶材质识别

一般名	NRB 丁腈橡胶	硅橡胶	聚氨酯橡胶	FKM (氟橡胶)	CR (氯丁橡胶)	EPR (乙丙橡胶)	导电性NRB (丁腈橡胶)	导电性硅橡胶	导电性硅橡胶海绵	导电性CR海绵 (氯丁橡胶)
橡胶色	黑	白色	茶	黑	黑	黑	黑	黑	黑	黑
识别(点或压痕)	—	—	—	·绿色1点 ·⊕	·红色1点 ·⊙	·⊕	·银色1点	·银色2点	—	—

真空吸盘系列

天行大头吸盘系列

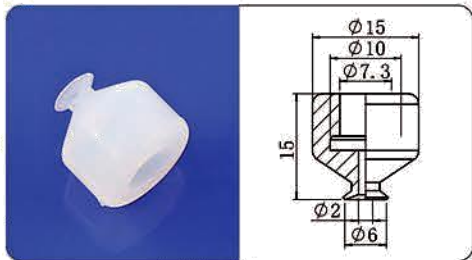

HSP-6 白色(S)

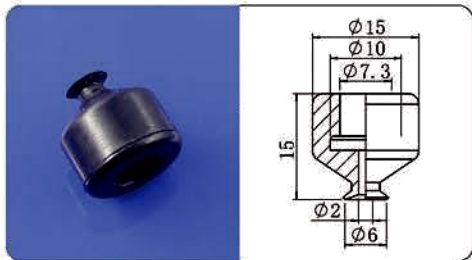

HSP-6 黑色(N)

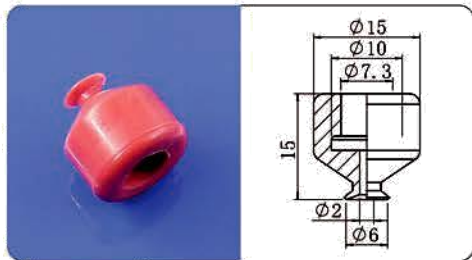

HSP-6 红色(R)

S:白色 硅橡胶 N:黑色 丁腈橡胶 R:红色 硅胶材质 多种款式 非标可定做

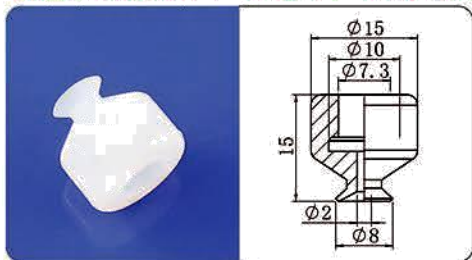

HSP-8

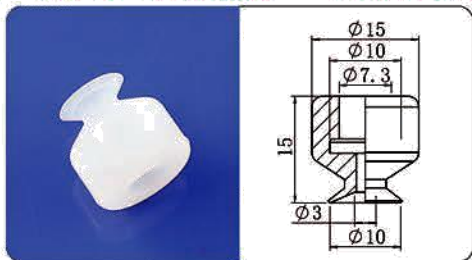

HSP-10

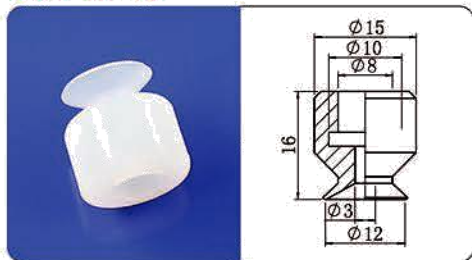

HSP-12

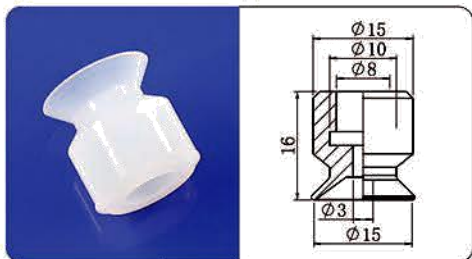

HSP-15

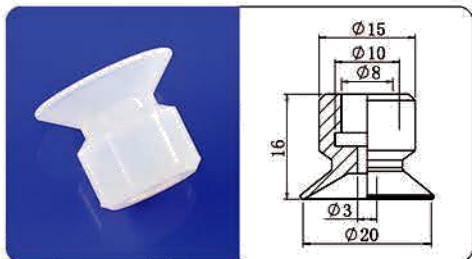

HSP-20

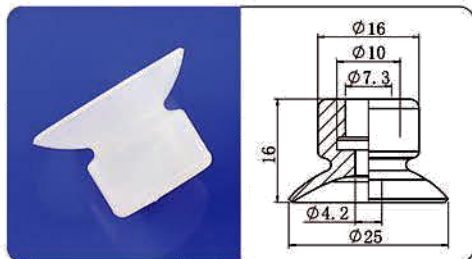

HSP-25

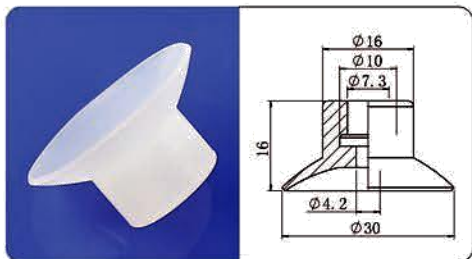

HSP-30

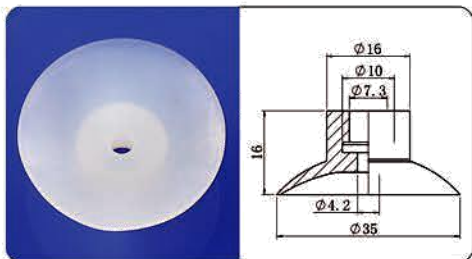

HSP-35

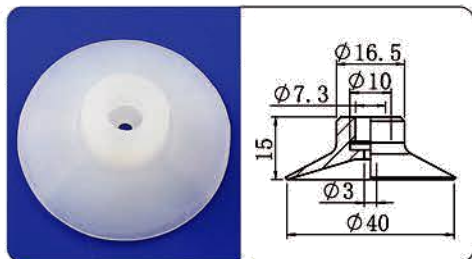

HSP-40

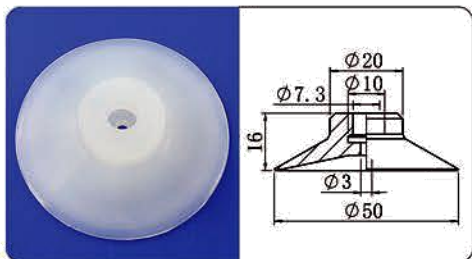

HSP-50

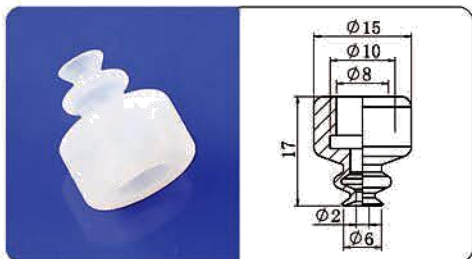

HSP-6-2

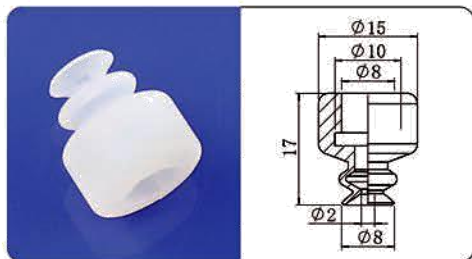

HSP-8-2

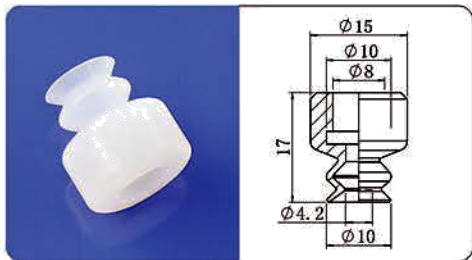

HSP-10-2

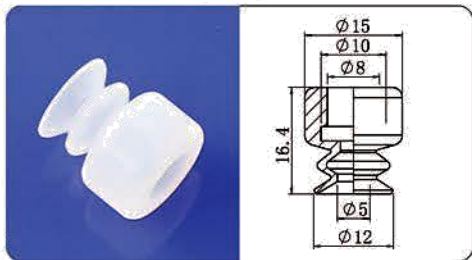

HSP-12-2

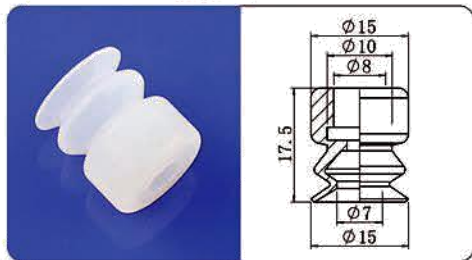

HSP-15-2

天行大头吸盘系列

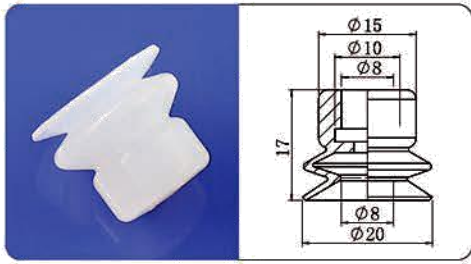

HSP-20-2

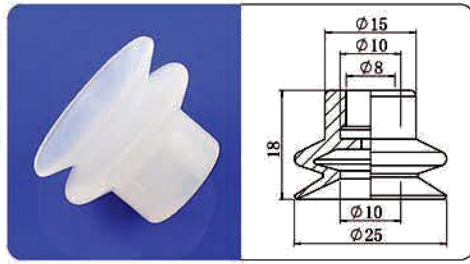

HSP-25-2

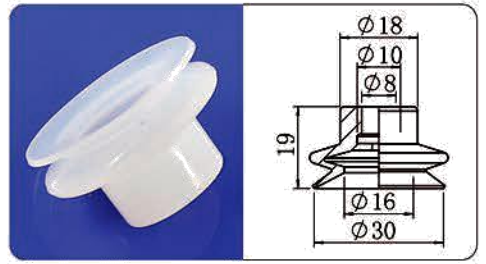

HSP-30-2

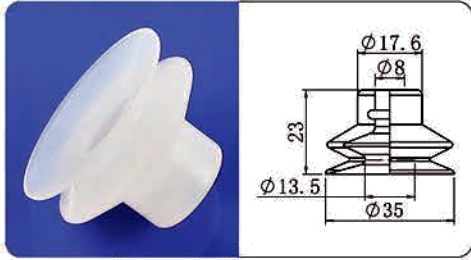

HSP-35-2

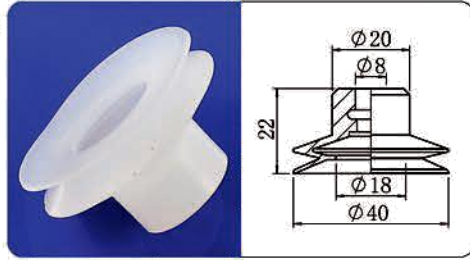

HSP-40-2

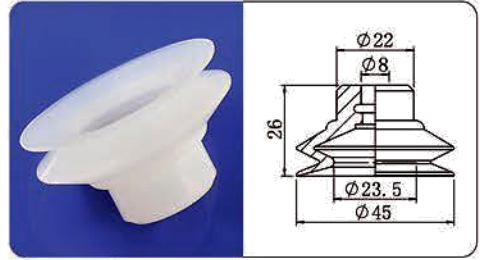

HSP-45-2

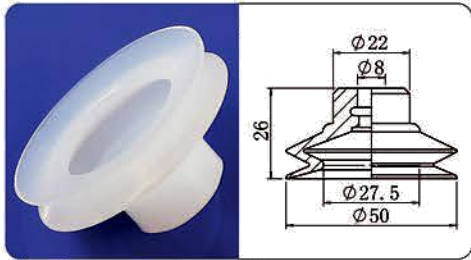

HSP-50-2

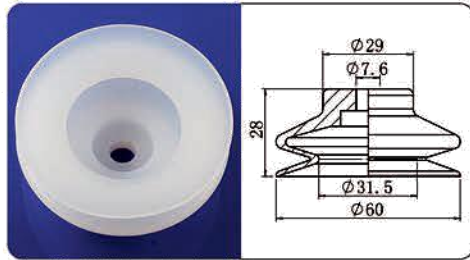

HSP-60-2

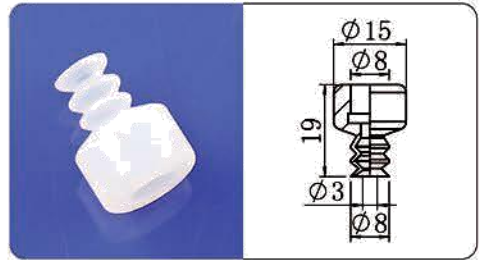

HSP-8-3

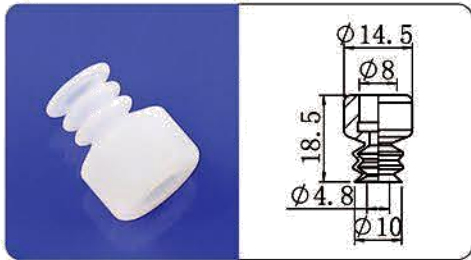

HSP-10-2

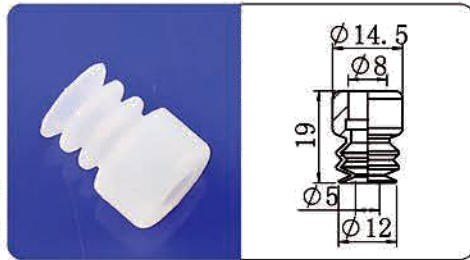

HSP-12-3

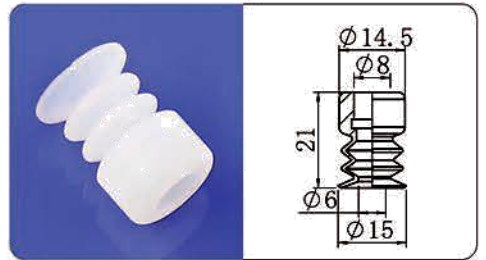

HSP-15-3(大孔)

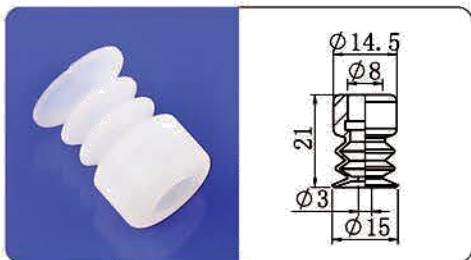

HSP-15-3X(小孔)

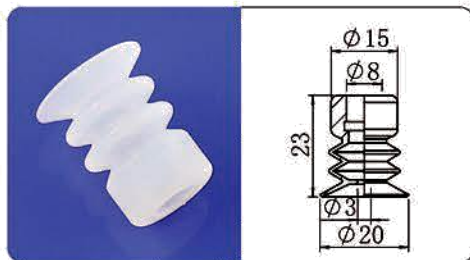

HSP-20-3

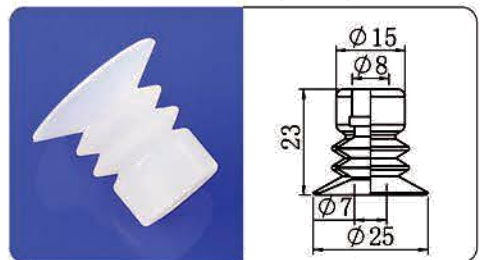

HSP-25-3

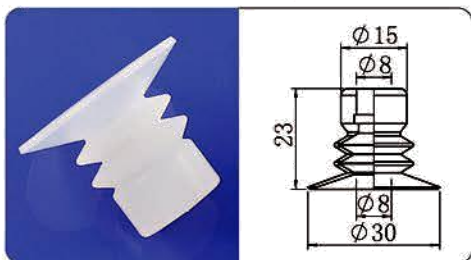

HSP-30-3

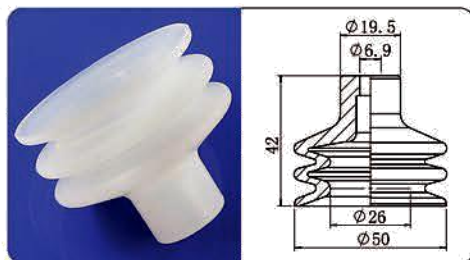

HSP-50-3

型号齐全 非标可定做

天行小头吸盘系列

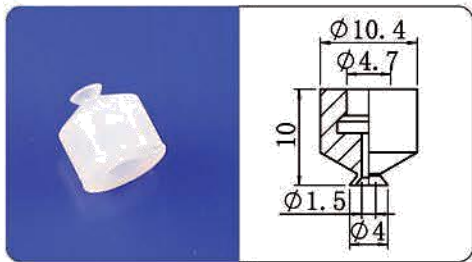

SP-4 白色(S)

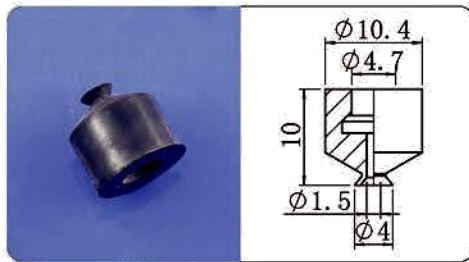

SP-4 黑色(N)

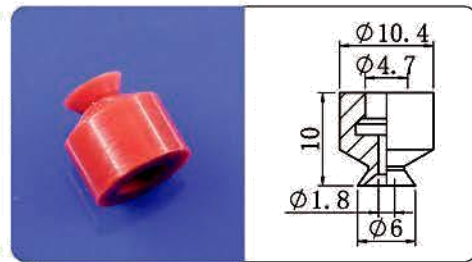

SP-6 红色(R)

S:白色 硅橡胶 N:黑色 丁腈橡胶 R:红色 硅胶材质 多种款式 非标可定做

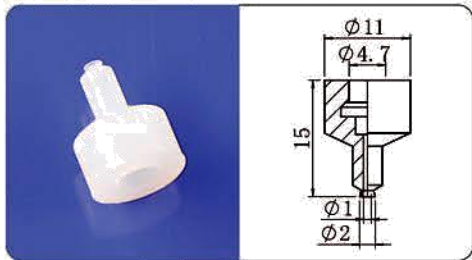

SPL-2

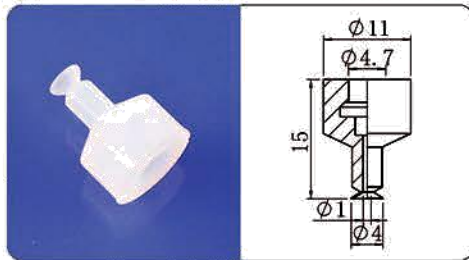

SPL-4

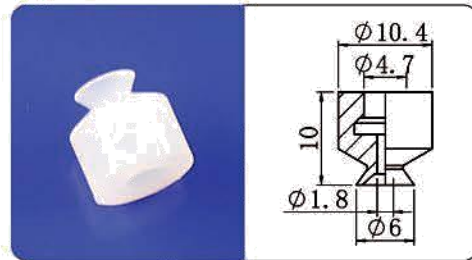

SP-6

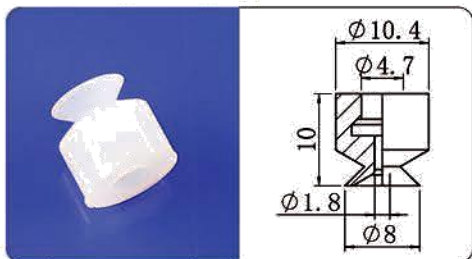

SP-8

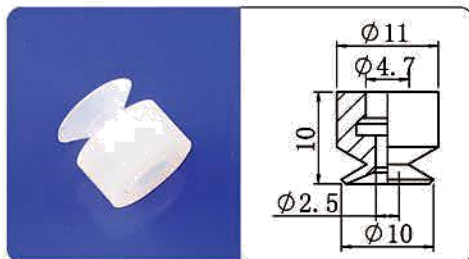

SP-10

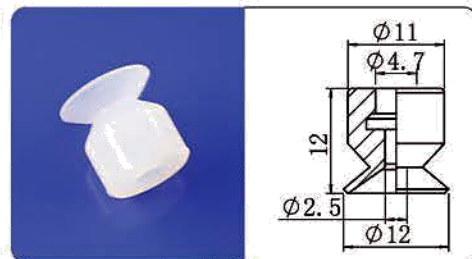

SP-12

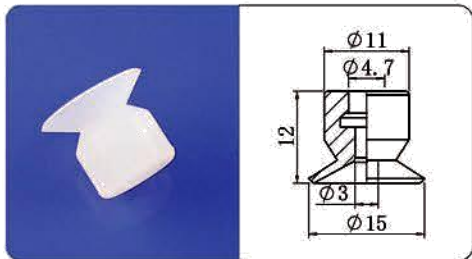

SP-15

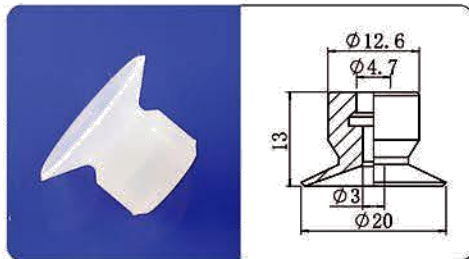

SP-20

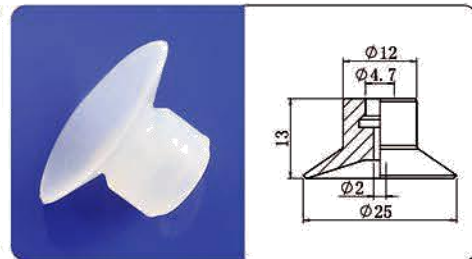

SP-25

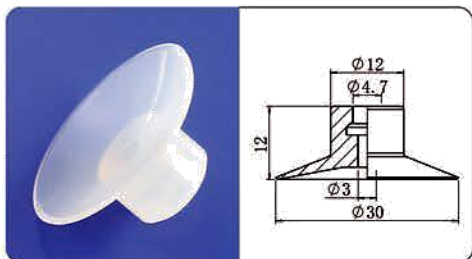

SP-30

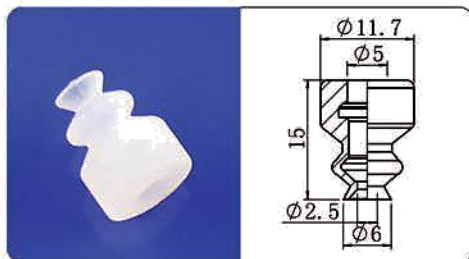

SP-6-2

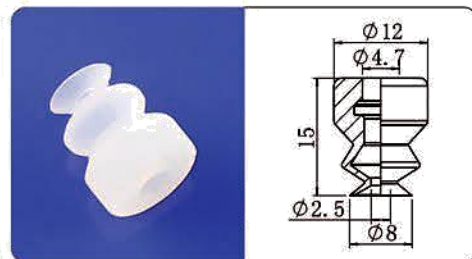

SP-8-2

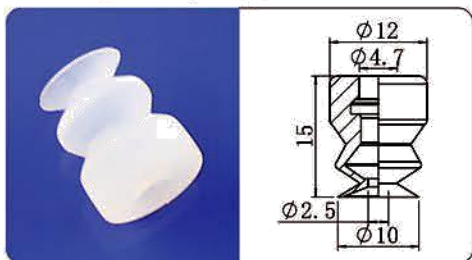

SP-10-2

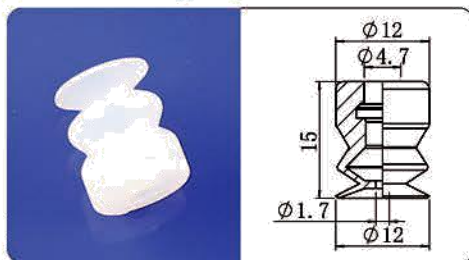

SP-12-2

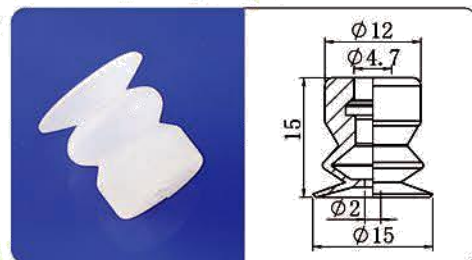

SP-15-2

真空吸盘系列

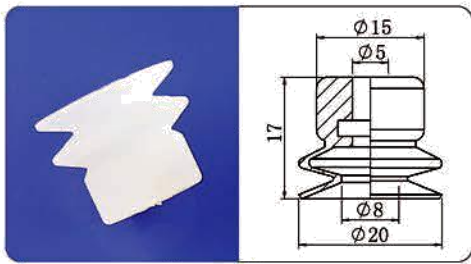

SP-20-2

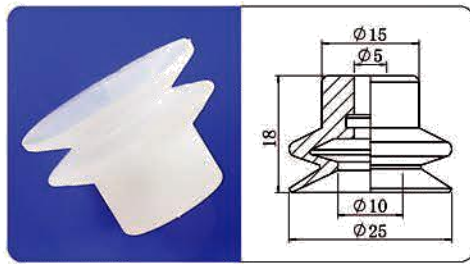

SP-25-2

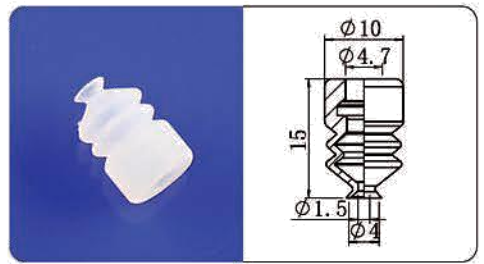

SP-4-3

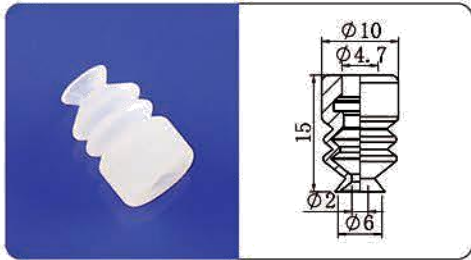

SP-6-3

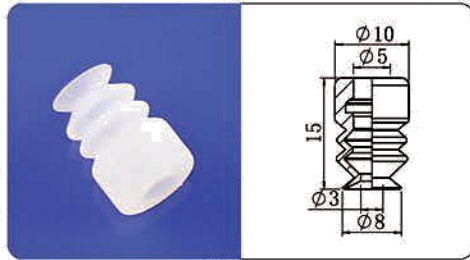

SP-8-3

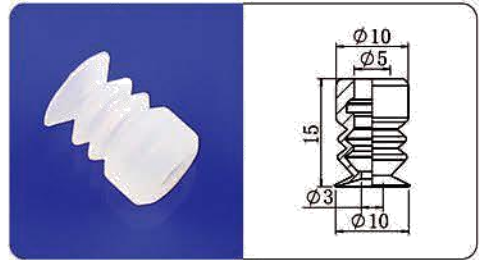

SP-10-3

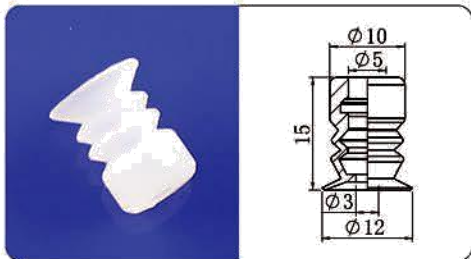

SP-12-3

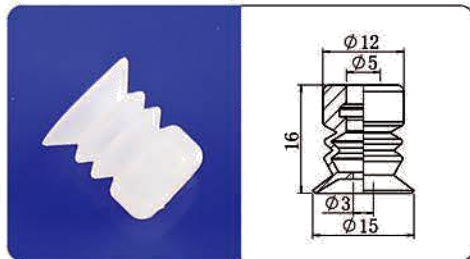

SP-15-3

型号齐全 非标可定做

○ SMC CP系列平形(U)系列

S:白色 硅橡胶

N:黑色 丁腈橡胶

多种款式 非标可定做

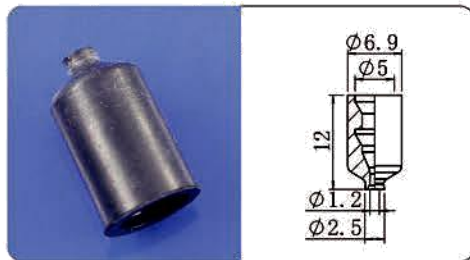

CP-02UN

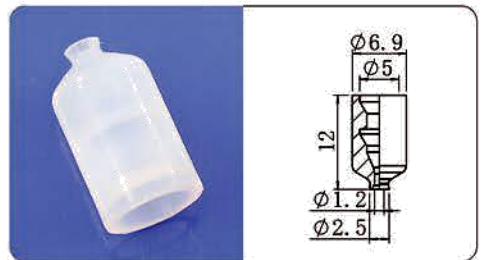

CP-02US

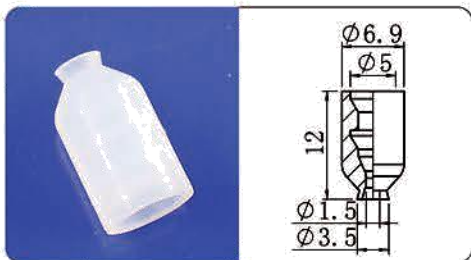

CP-03U

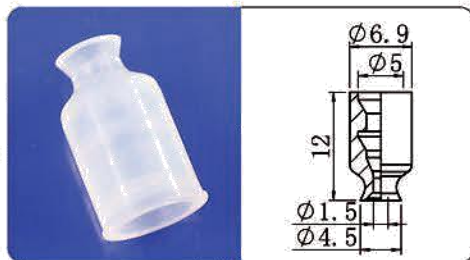

CP-04U

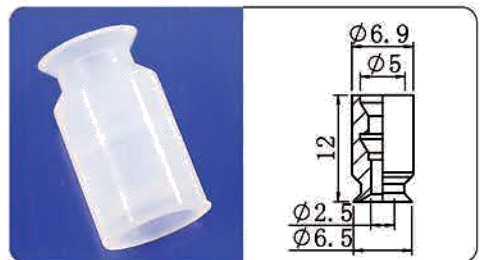

CP-06U

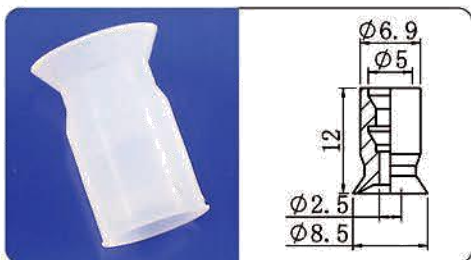

CP-08U

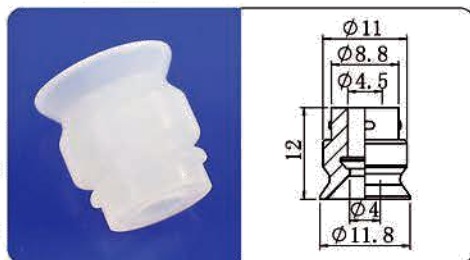

CP-10U

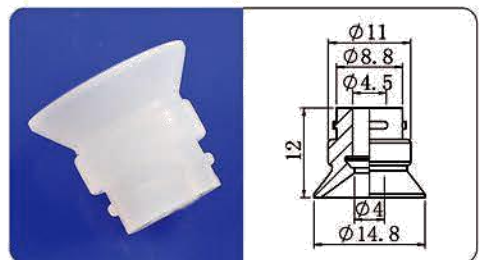

CP-13U

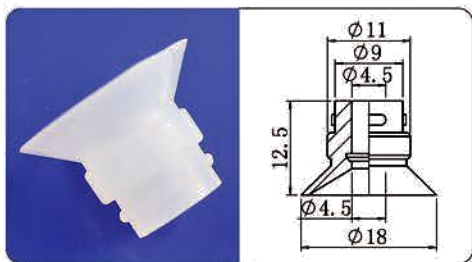

CP-16U

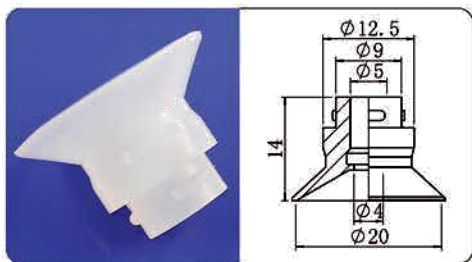

CP-20U

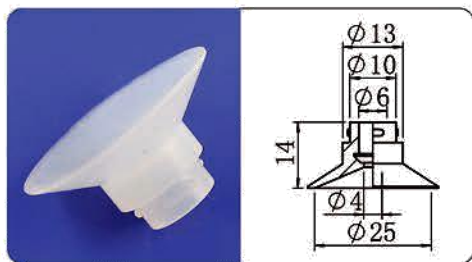

CP-25U

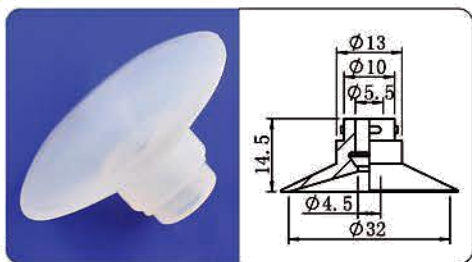

CP-32U

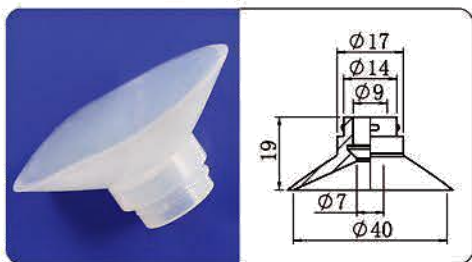

CP-40U

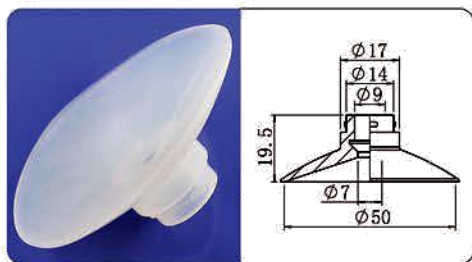

CP-50U

SMC CP迷你吸盘系列

S:白色 硅橡胶

N:黑色 丁腈橡胶

多种款式 非标可定做

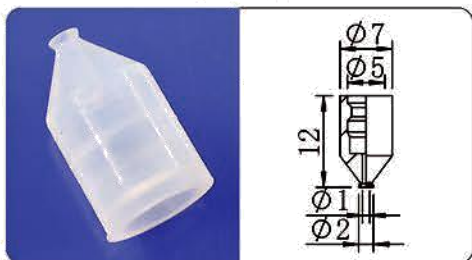

CP-2S

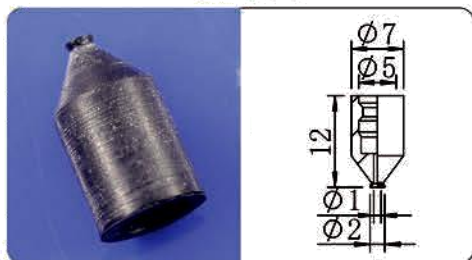

CP-2N

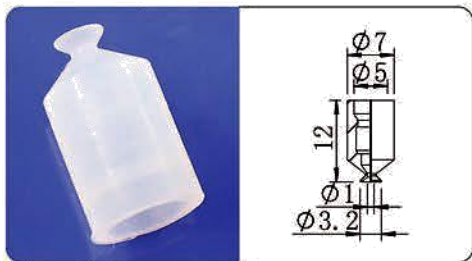

CP-3

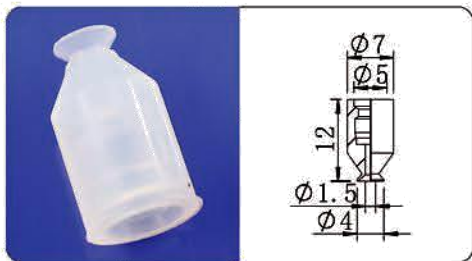

CP-4

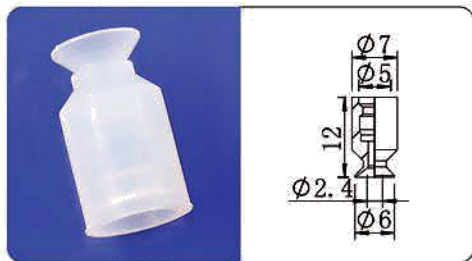

CP-6

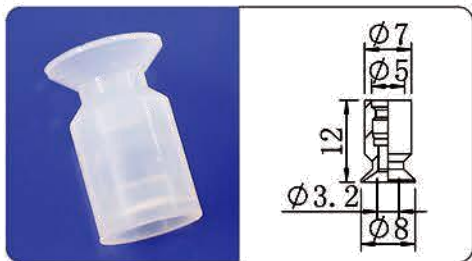

CP-8

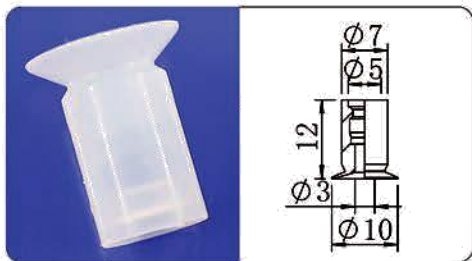

CP-10

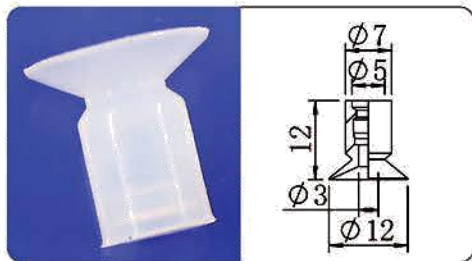

CP-12

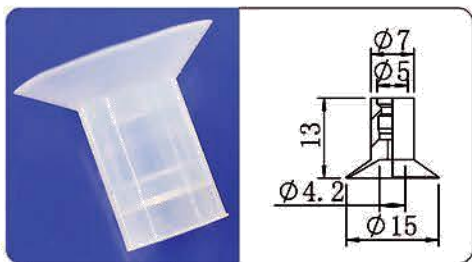

CP-15

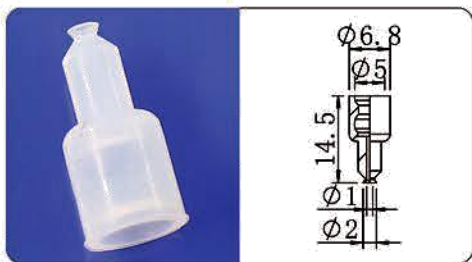

CPL-2

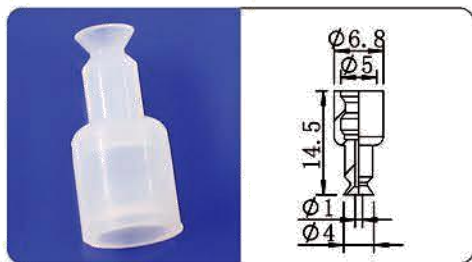

CPL-4

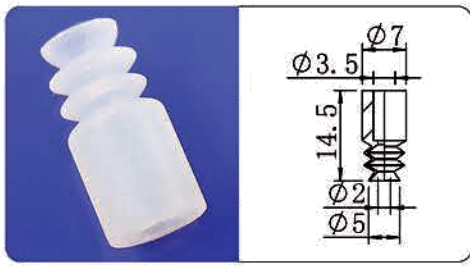

BT-5S

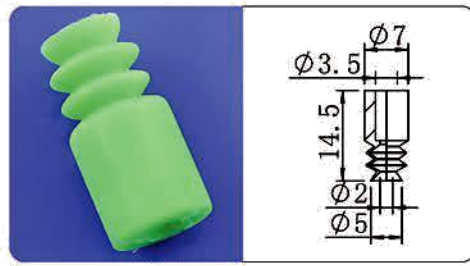

BT-5绿

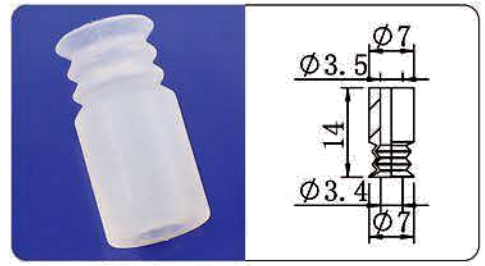

BT-7S

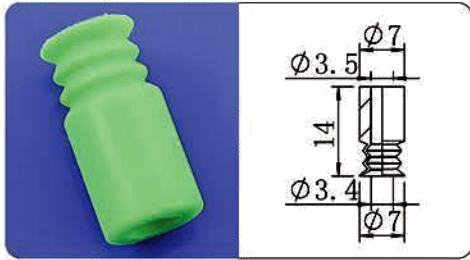

BT-7绿

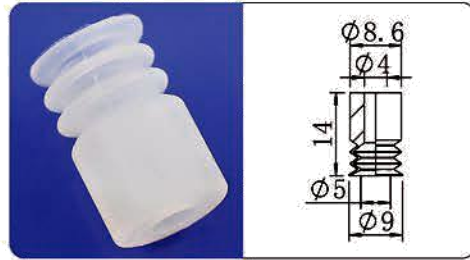

BT-9S

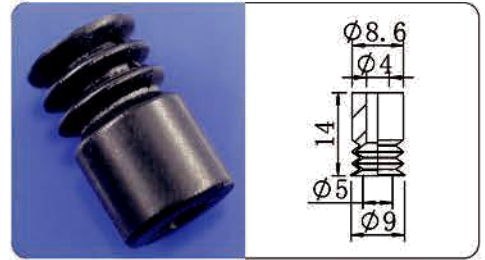

BT-9N

○SMC B风琴型吸盘系列

S:白色 硅橡胶

N:黑色 丁腈橡胶

多种款式 非标可定做

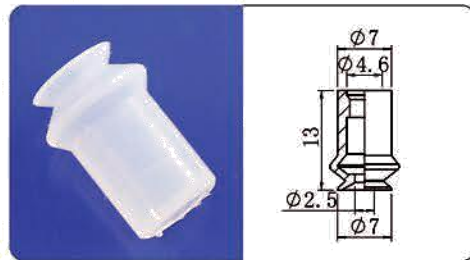

CP-06BS(白色)

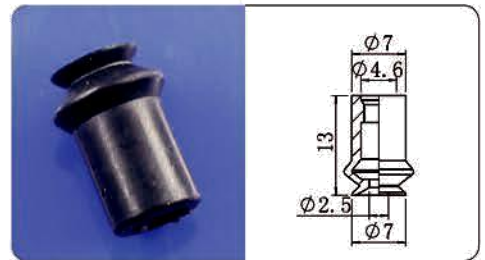

CP-06BN(黑色)

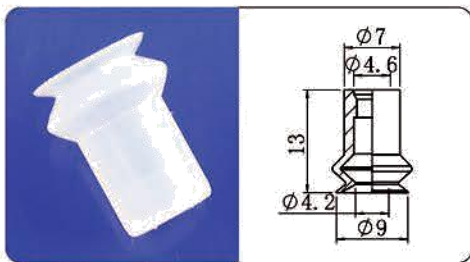

CP-08B

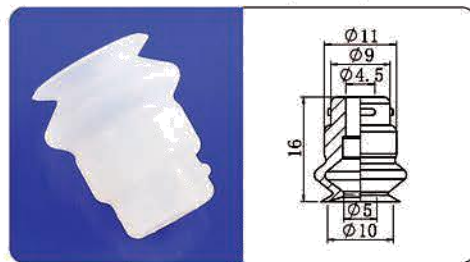

CP-10B

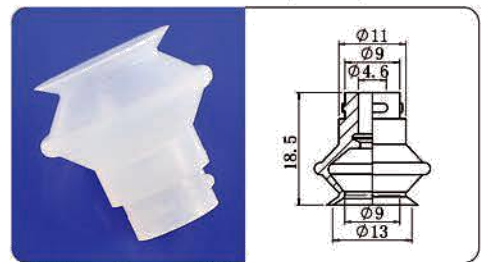

CP-13B

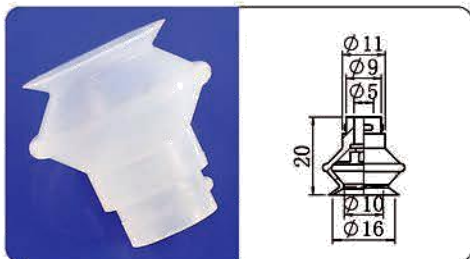

CP-16B

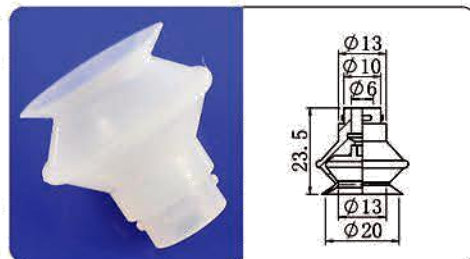

CP-20B

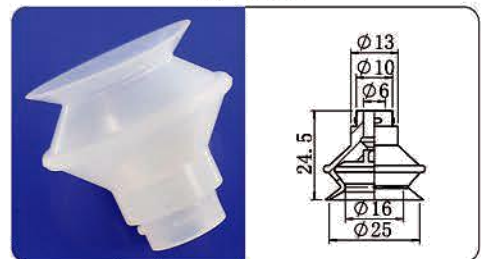

CP-25B

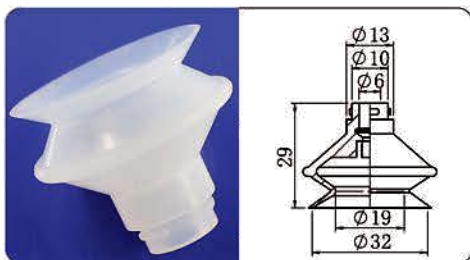

CP-32B

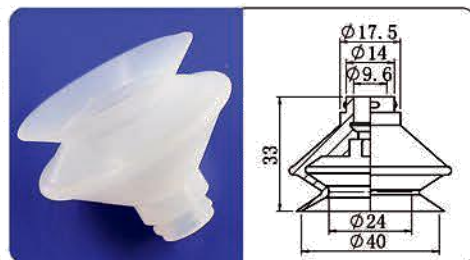

CP-40B

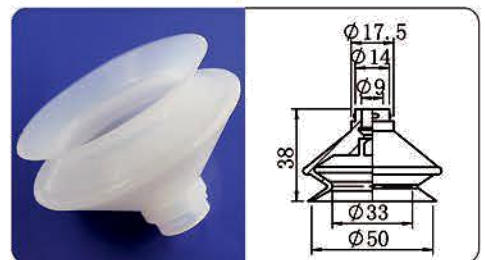

CP-50B

◎ SMC C型(带肋)吸盘系列

S:白色 硅橡胶

N:黑色 丁腈橡胶

多种款式 非标可定做

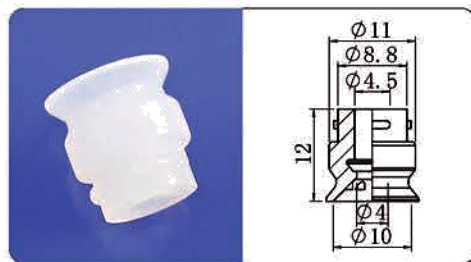

CP-10CS

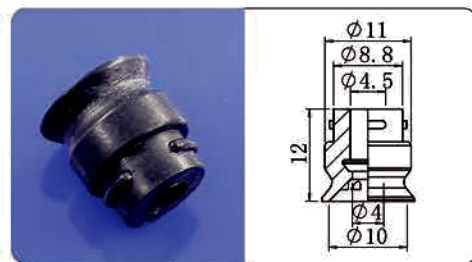

CP-10CN

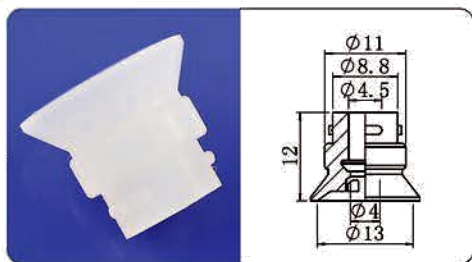

CP-13C

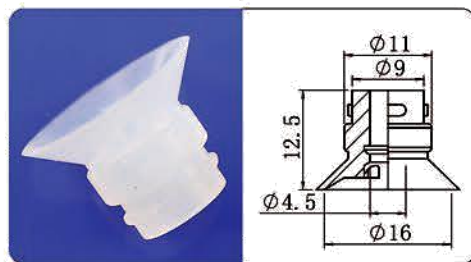

CP-16C

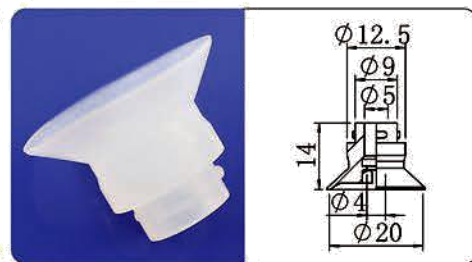

CP-20C

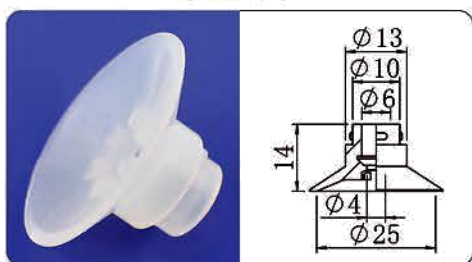

CP-25C

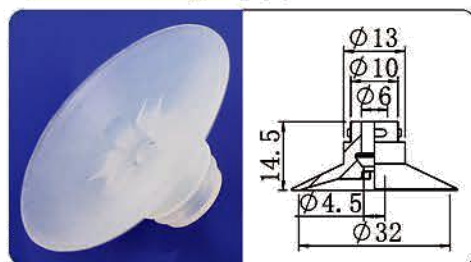

CP-32C

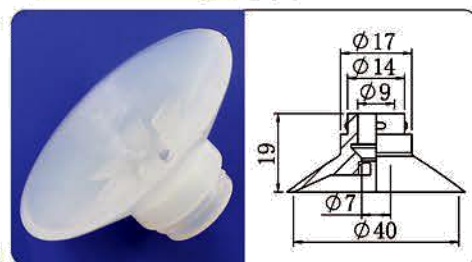

CP-40C

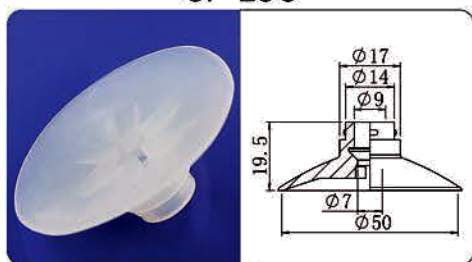

CP-50C



吸盘 金具 压环 型号配件齐全

◎ SMC D型(深形)吸盘系列

S:白色 硅橡胶

N:黑色 丁腈橡胶

多种款式 非标可定做

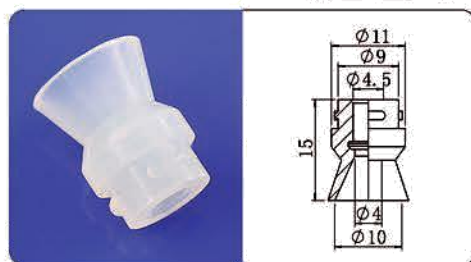

CP-10DS

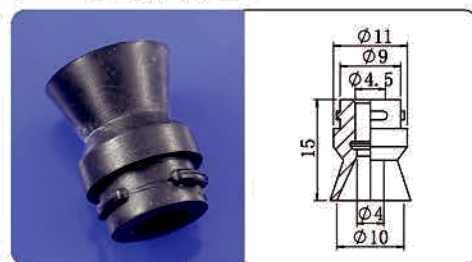

CP-10DN

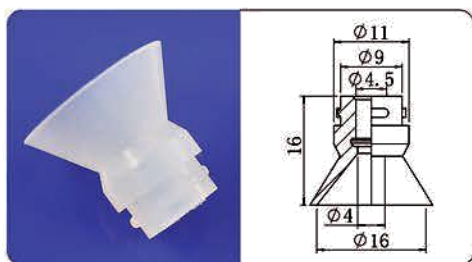

CP-16D

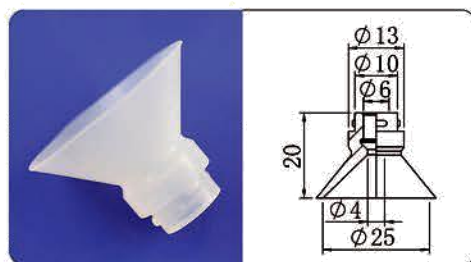

CP-25D

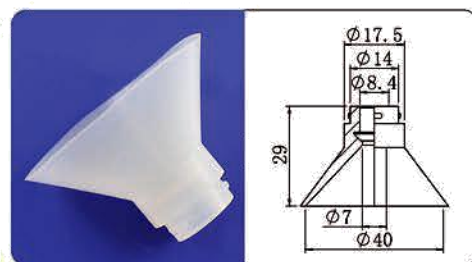

CP-40D

○SMC H型(重载)吸盘系列

S:白色 硅橡胶

N:黑色 丁腈橡胶

多种款式 非标可定做

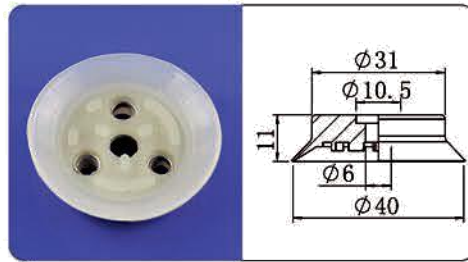

CP-40HS

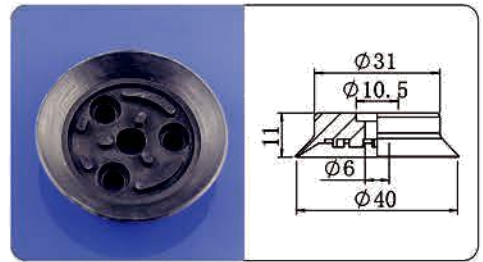

CP-40HN

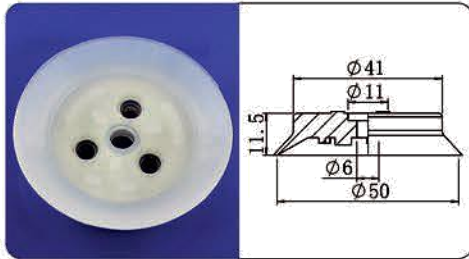

CP-50H

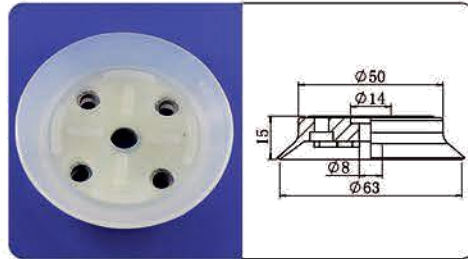

CP-63H

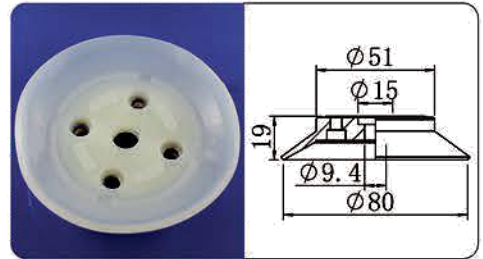

CP-80H

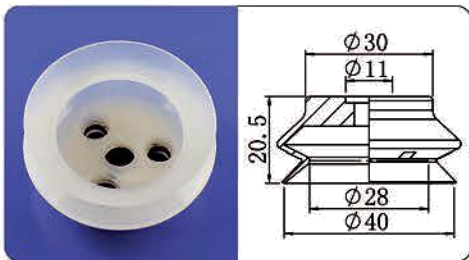

CP-40HB

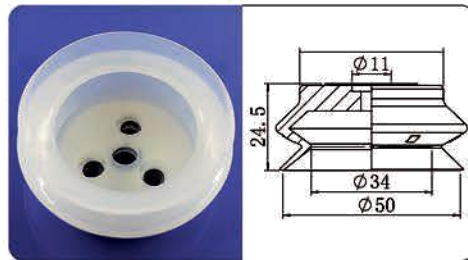

CP-50HB

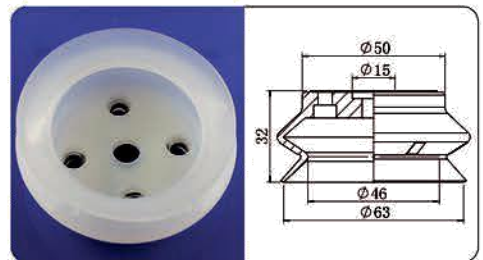

CP-63HB

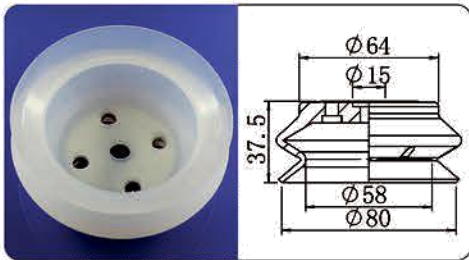

CP-80HB



吸盘配套金具

型号齐全 可定做

○SMC CP3新款吸盘系列

S:白色 硅橡胶

N:黑色 丁腈橡胶

多种款式 非标可定做

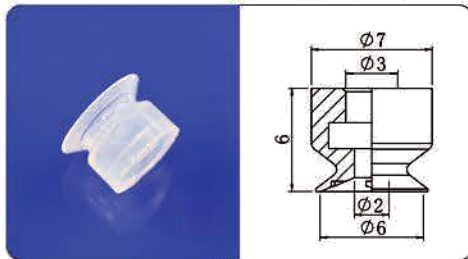

CP3-06UMS

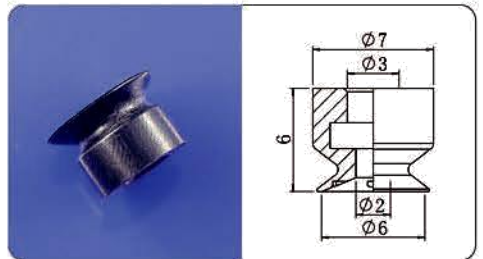

CP3-06UMN

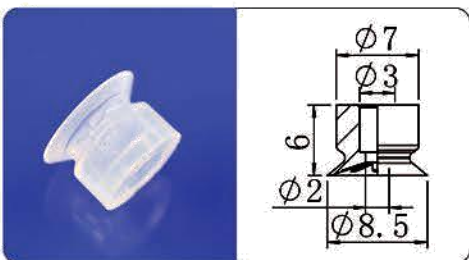

CP3-08UM

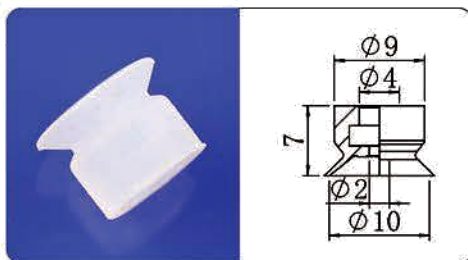

CP3-10UM

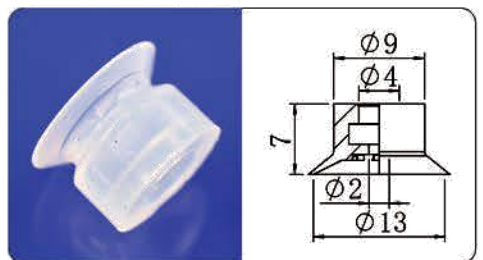

CP3-13UM

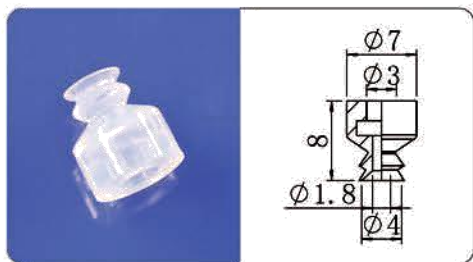

CP3-04BS

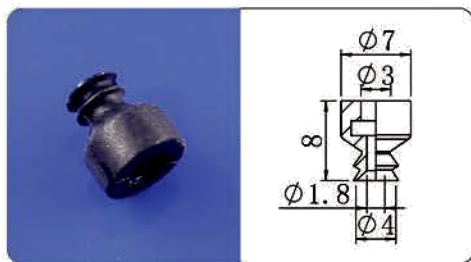

CP3-04BN

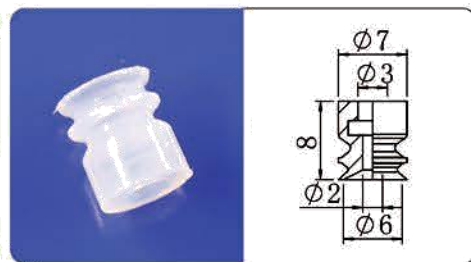

CP3-06BS

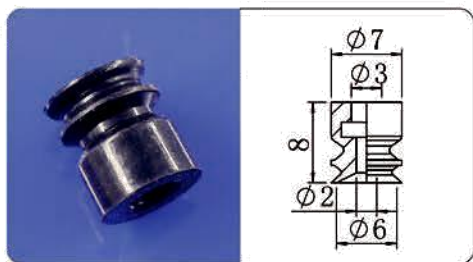

CP3-06BN

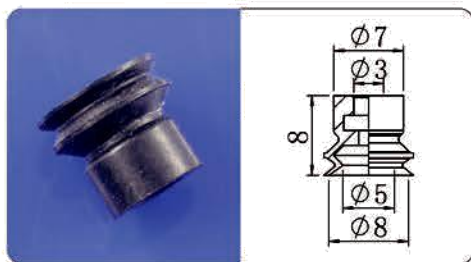

CP3-08BN

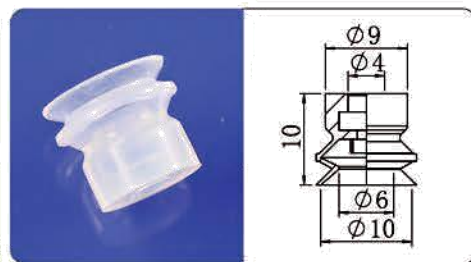

CP3-10BS

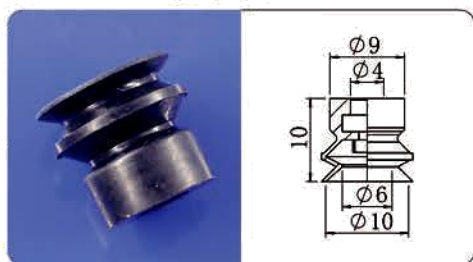

CP3-10BN

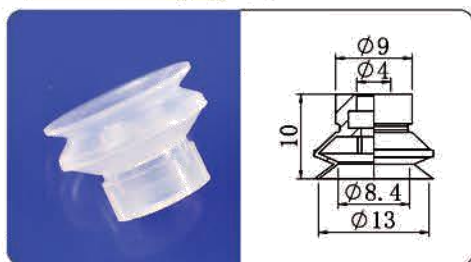

CP3-13BS

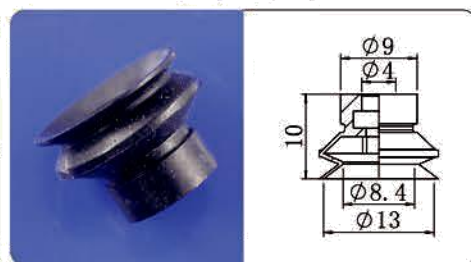

CP3-13BN

○妙德 PF吸盘系列
S:白色 硅橡胶
N:黑色 丁腈橡胶
多种款式 非标可定做

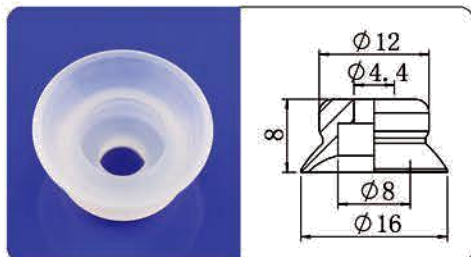

PF-15S

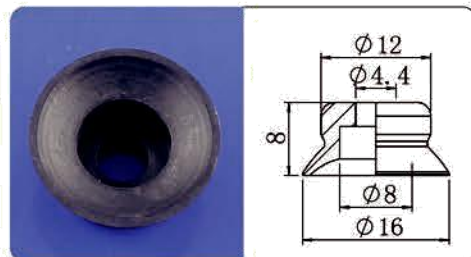

PF-15N

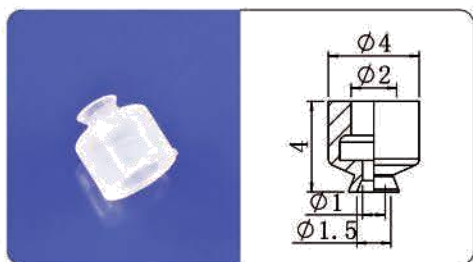

PF-1.5

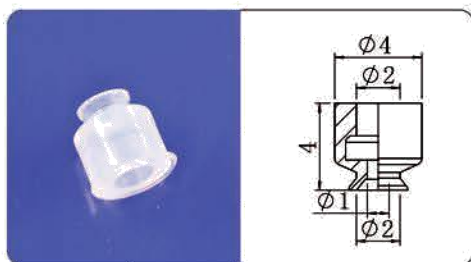

PF-2

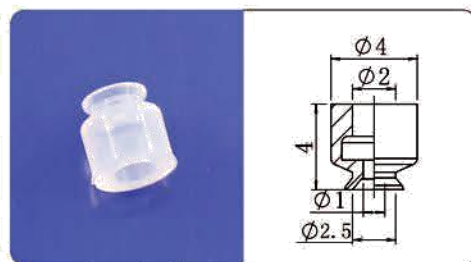

PF-2.5

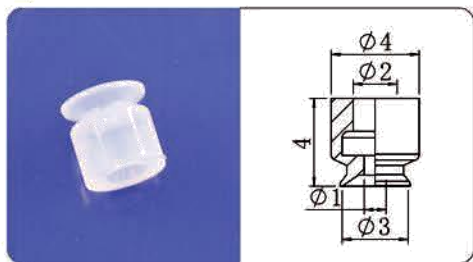

PF-3

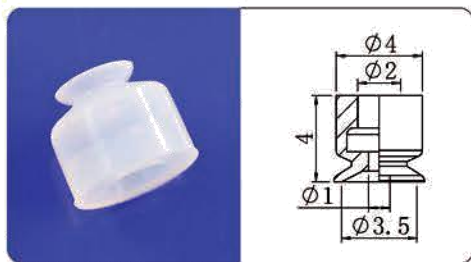

PF-3.5

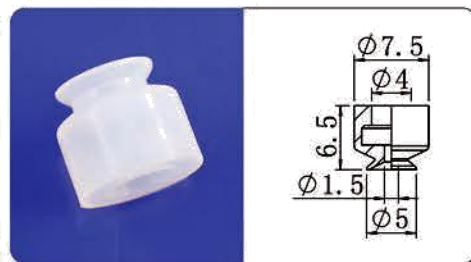

PF-5

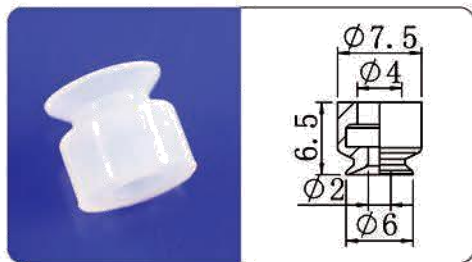

PF-6

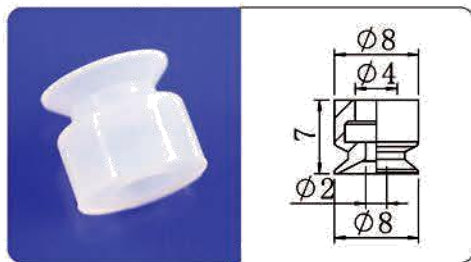

PF-8

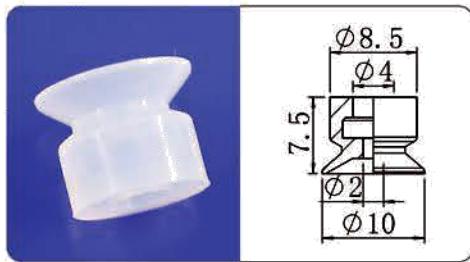

PF-10

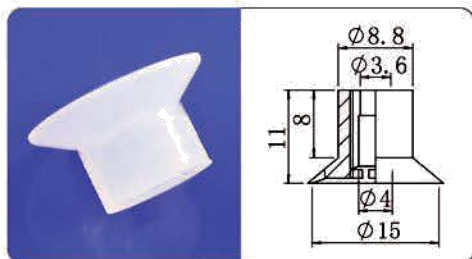

PF-15A(带肋)

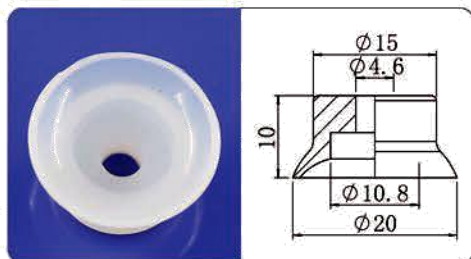

PF-20

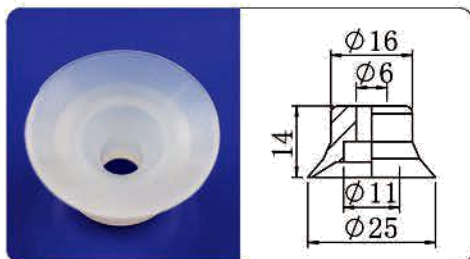

PF-25

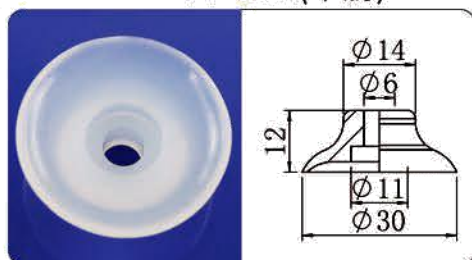

PF-30

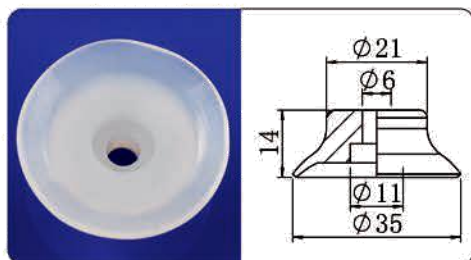

PF-35

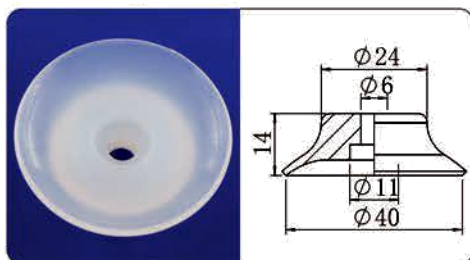

PF-40

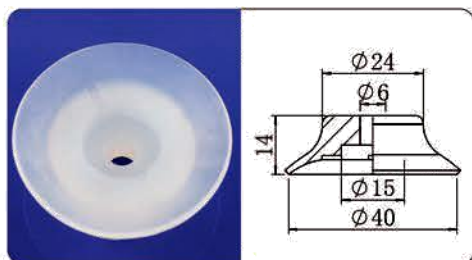

PF-40A(防滑)

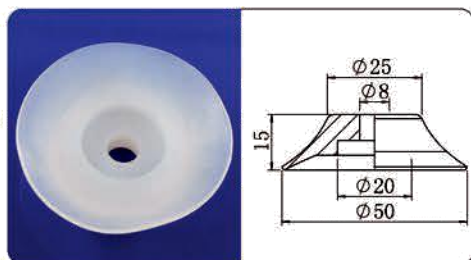

PF-50

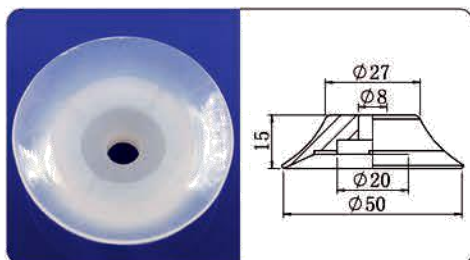

PF-50A(防滑)

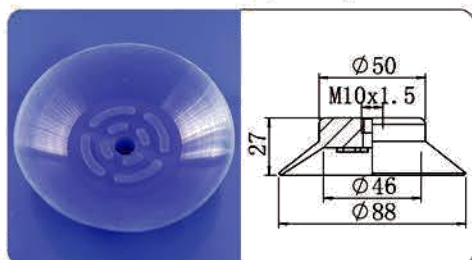

PA-88蓝色

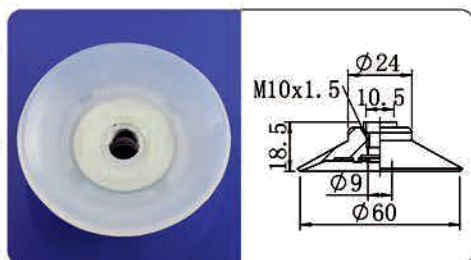

PF-60(1.0牙)

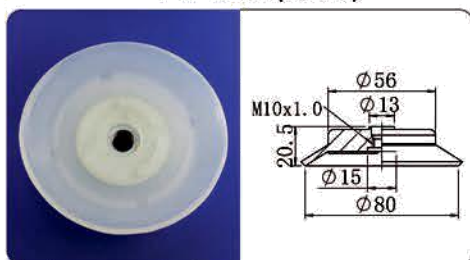

PF-80S

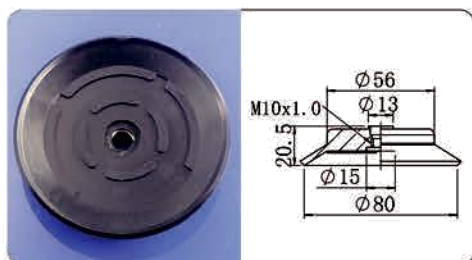

PF-80N

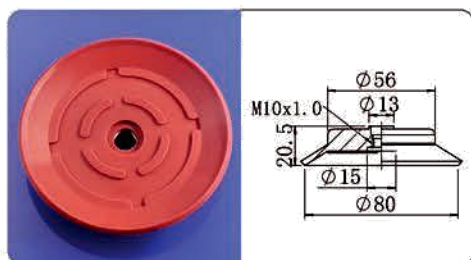

PF-80R(耐高温)

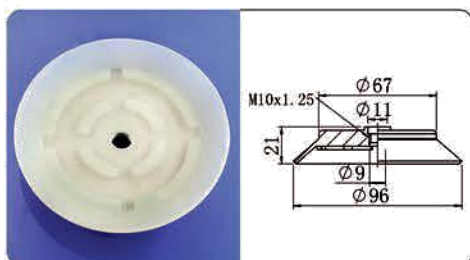

PF-95S

○妙德 PJG吸盘系列

S:白色 硅橡胶
N:黑色 丁腈橡胶
多种款式 非标可定做

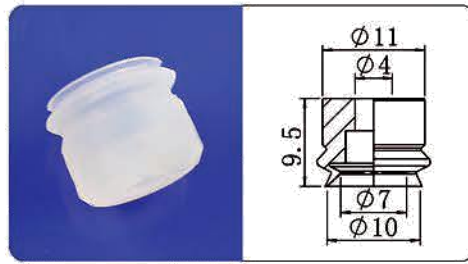

PJG-10S

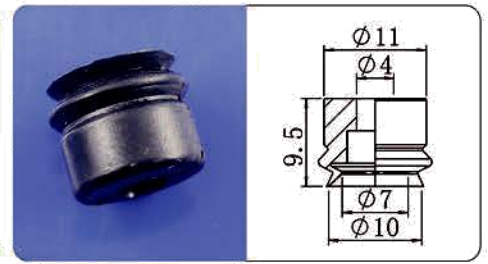

PJG-10N

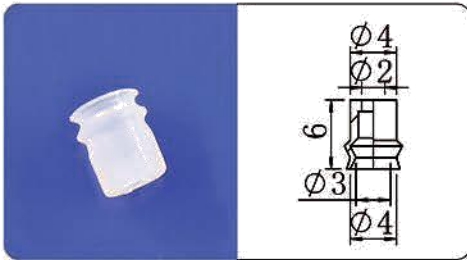

PJG-4

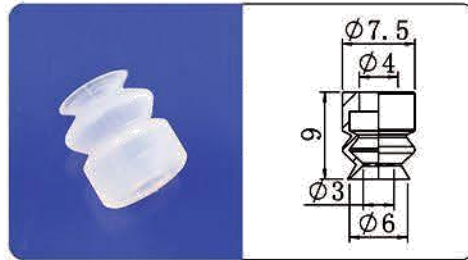

PJG-6

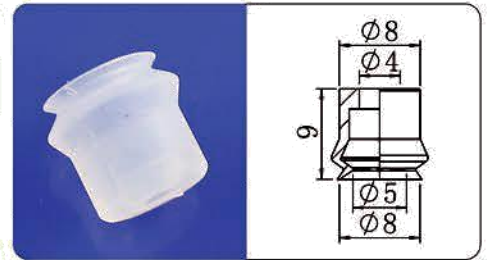

PJG-8

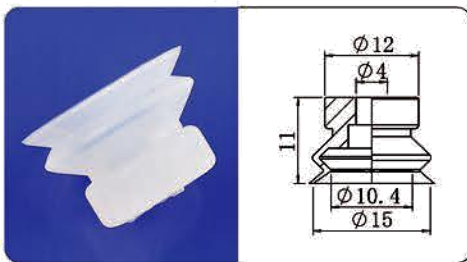

PJG-15

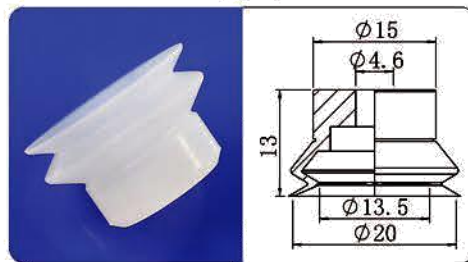

PJG-20

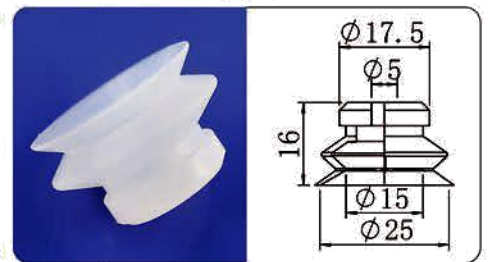

PJG-25

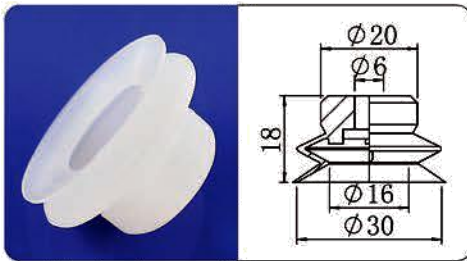

PJG-30

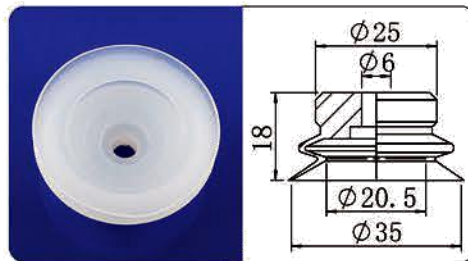

PJG-35

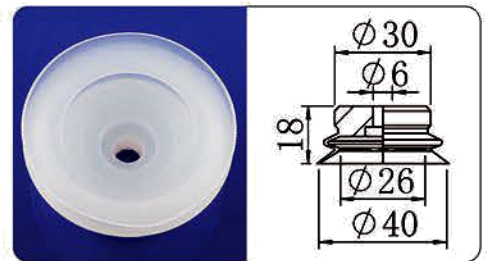

PJG-40

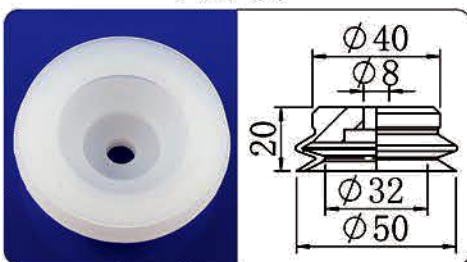

PJG-50

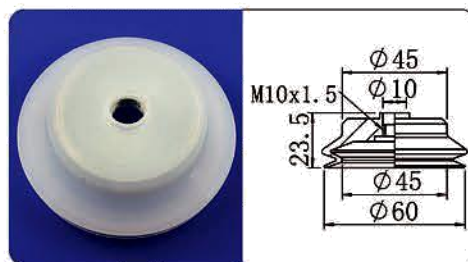

PJG-60(1.0牙)

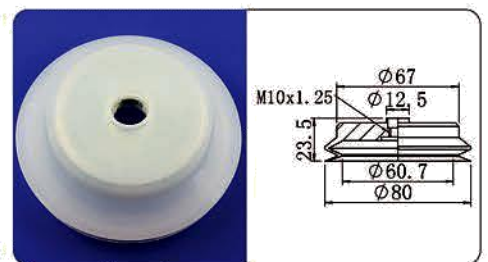

PJG-80(1.25牙)

○妙德 PC吸盘系列

S:白色 硅橡胶
N:黑色 丁腈橡胶
多种款式 非标可定做

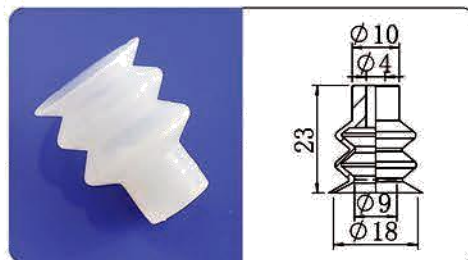

PC-18S

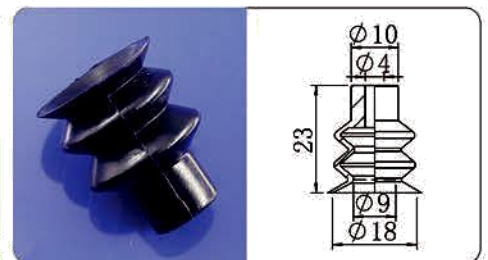

PC-18N

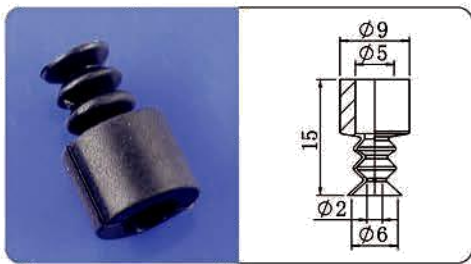

PC-6

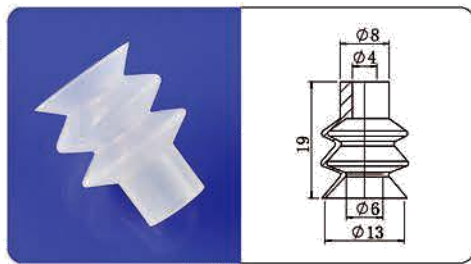

PC-13

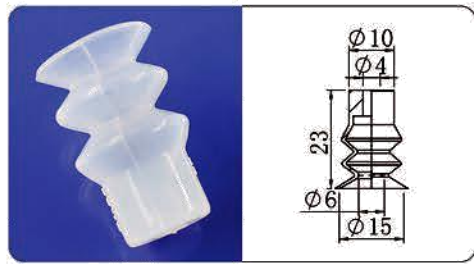

PC-15

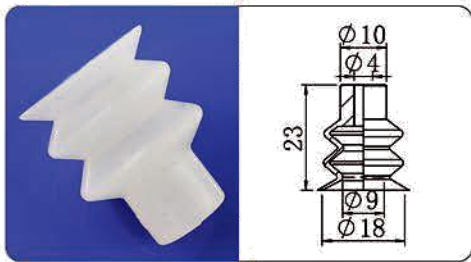

PC-18

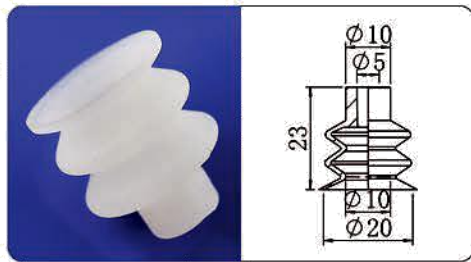

PC-20

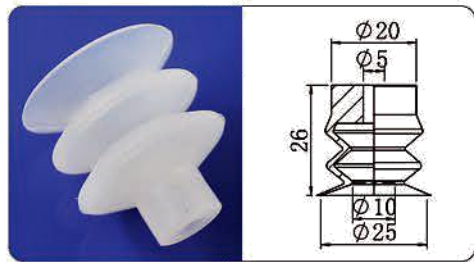

PC-25

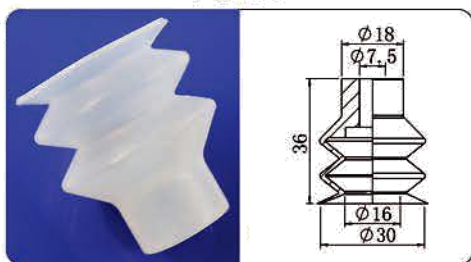

PC-30



型号齐全 非标可定做

○ 星塔 SR吸盘系列

S:白色 硅橡胶

N:黑色 丁腈橡胶

R:红色 硅橡胶

多种款式 非标可定做

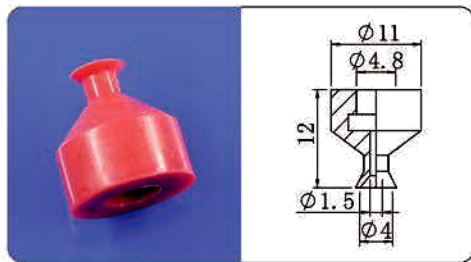

SR-4

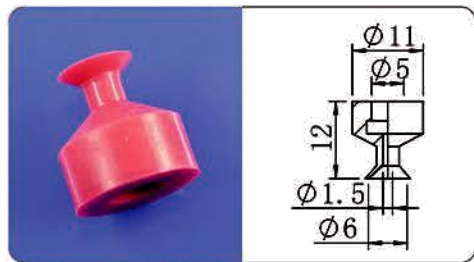

SR-6

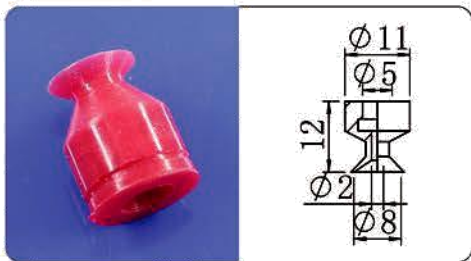

SR-8

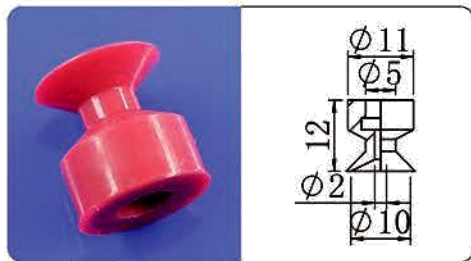

SR-10

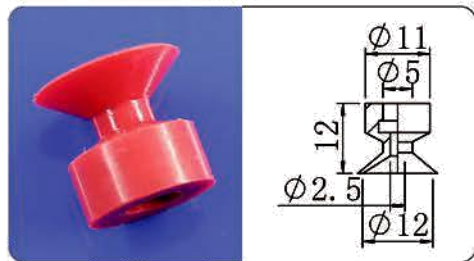

SR-12

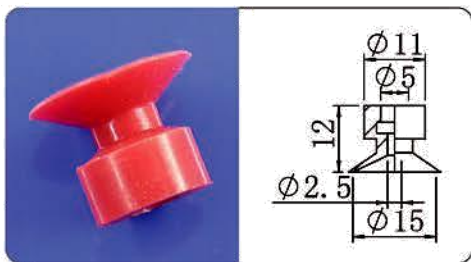

SR-15

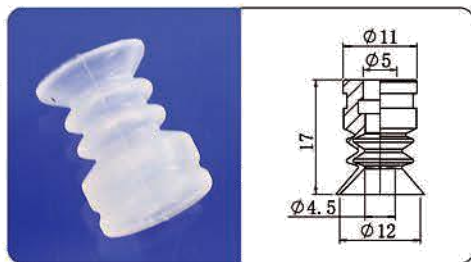

SR-12-3S

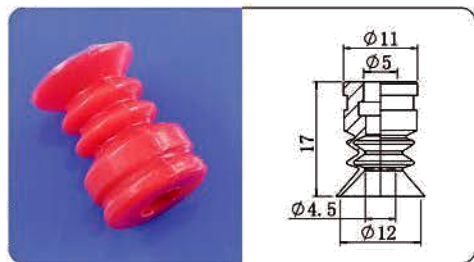

SR-12-3R

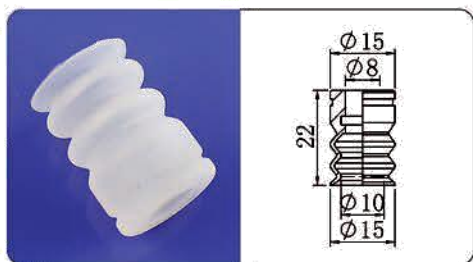

SR-15-3S

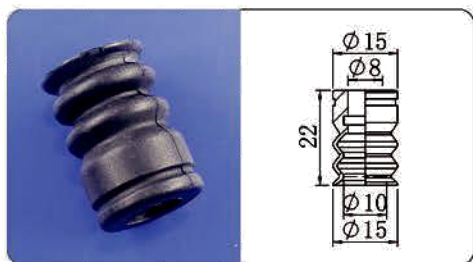

SR-15-3N

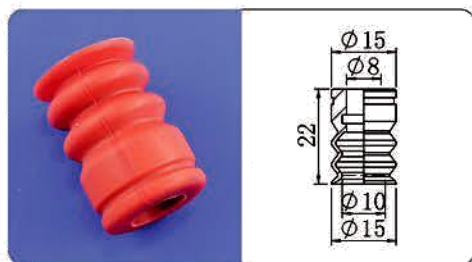

SR-15-3R

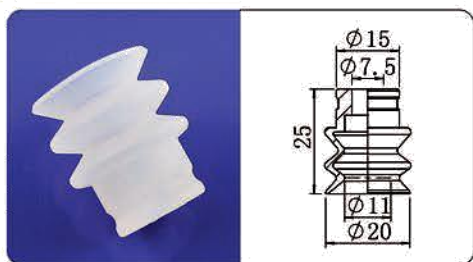

SR-20-3S

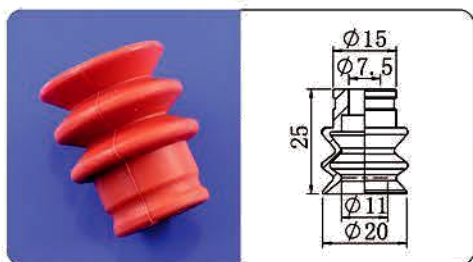

SR-20-3R

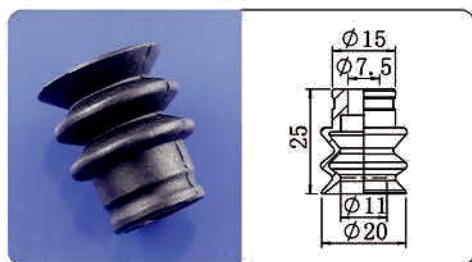

SR-20-3N

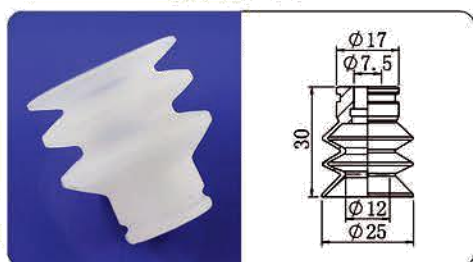

SR-25-3S

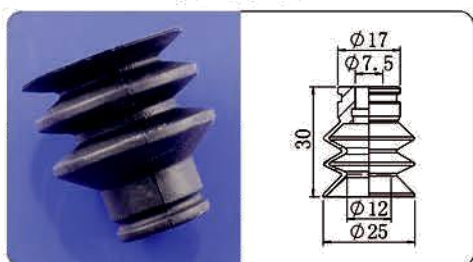

SR-25-3N

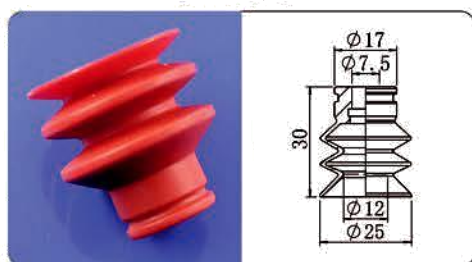

SR-25-3R

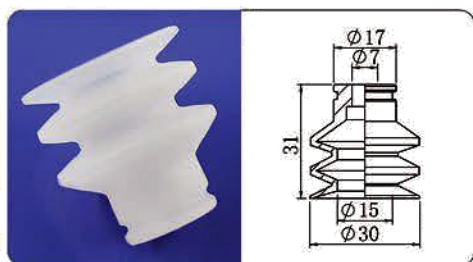

SR-30-3S

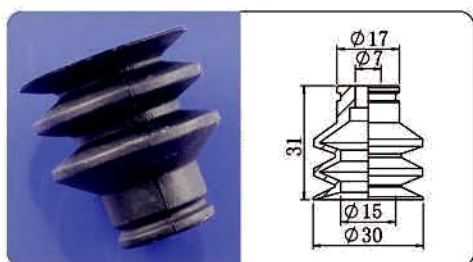

SR-30-3N

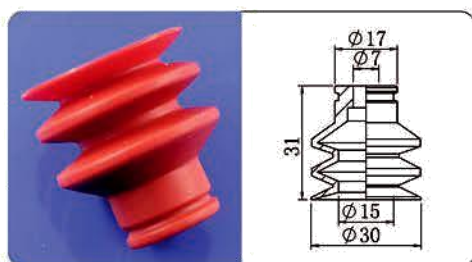

SR-30-3R

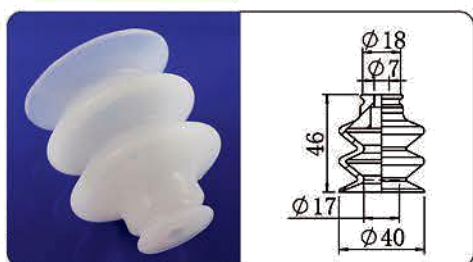

SR-40-3S

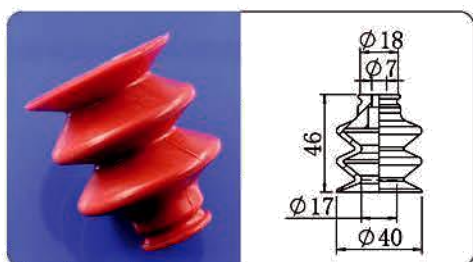

SR-40-3R

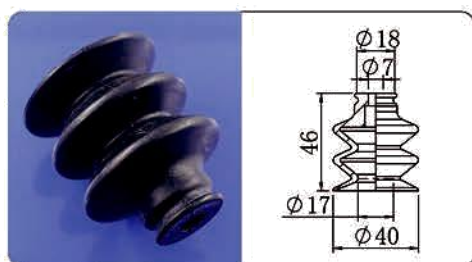

SR-40-3N

○哈模吸盘系列

S:白色 硅橡胶

N:黑色 丁腈橡胶

多种款式 非标可定做

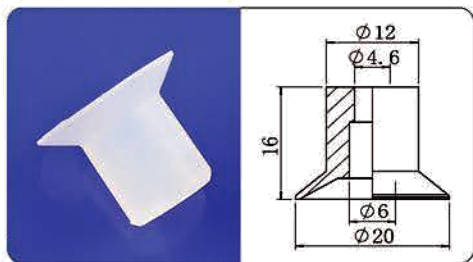

H-20S

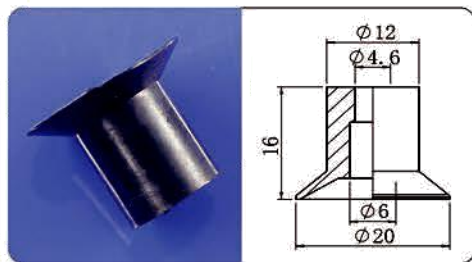

H-20N

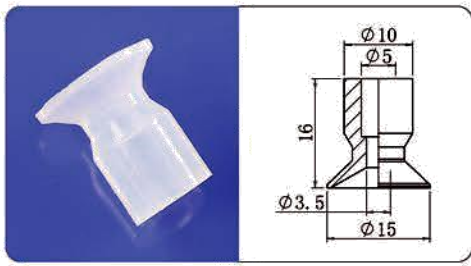

H-15

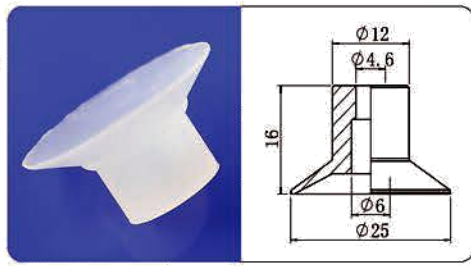

H-25

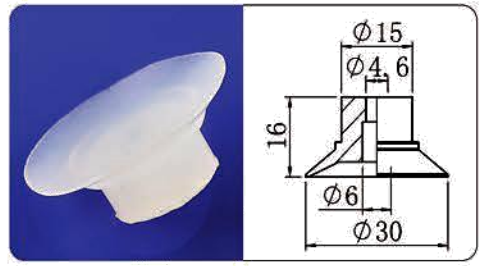

H-30

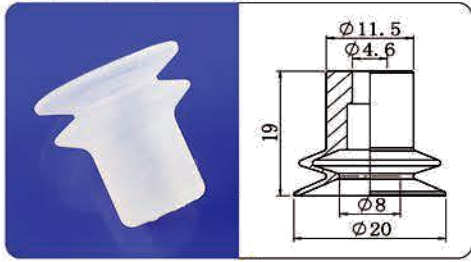

H-20-2

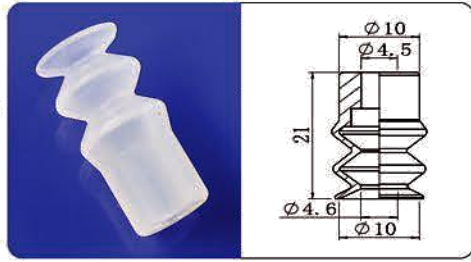

H-10-3

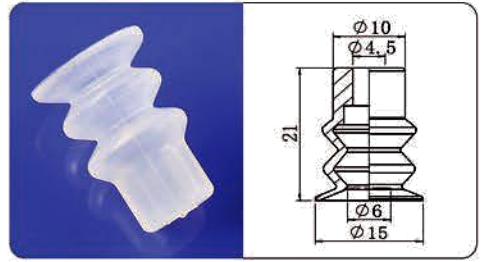

H-15-3

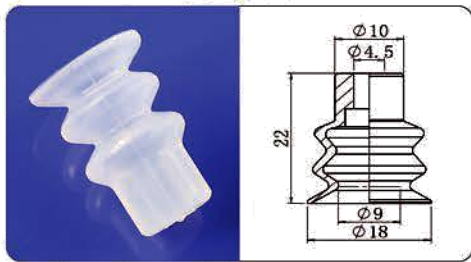

H-18-3

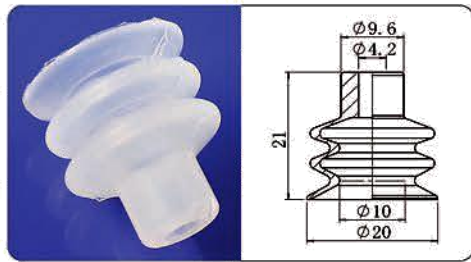

H-20-3

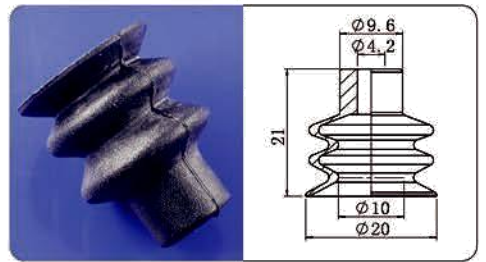

H-20-3

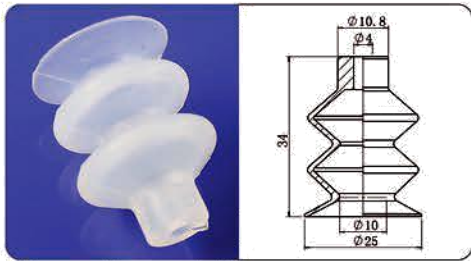

H-25-3

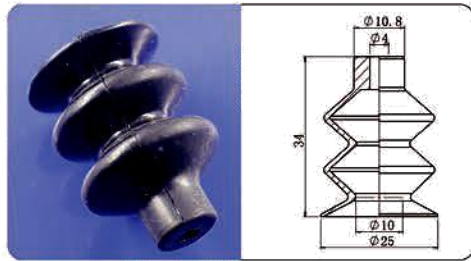

H-25-3

型号齐全 非标可定做

○匹士克吸盘系列
S:白色 硅橡胶
N:黑色 丁腈橡胶
多种款式 非标可定做

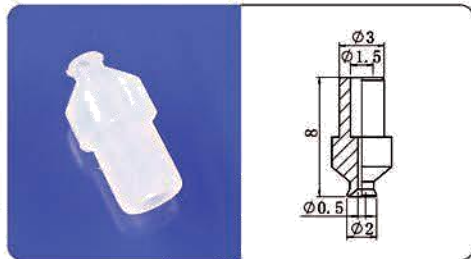

VP-02RS

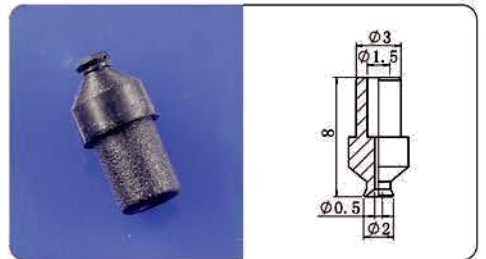

VP-02RN

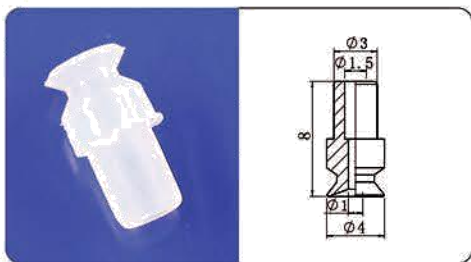

VP-04R

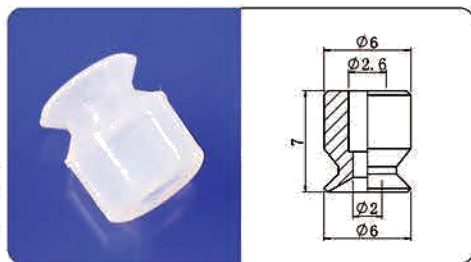

VP-06R

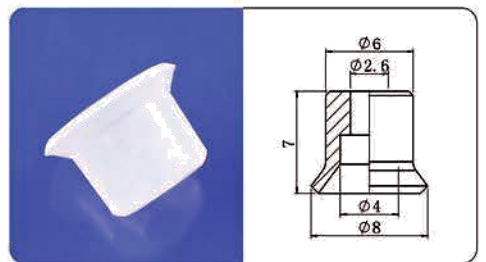

VP-08R

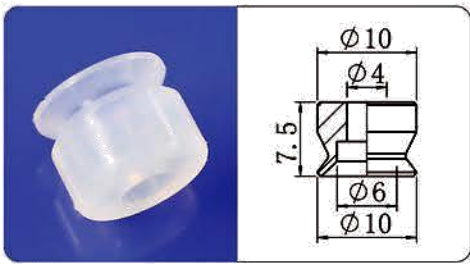

VP-10R

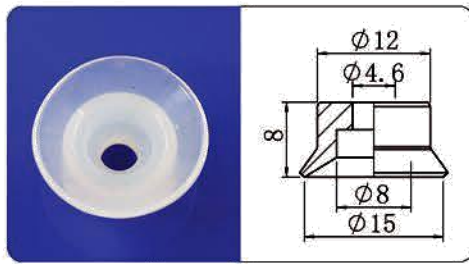

VP-15R

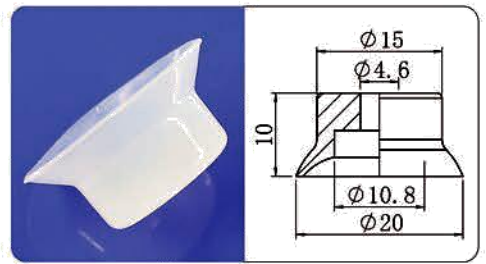

VP-20R

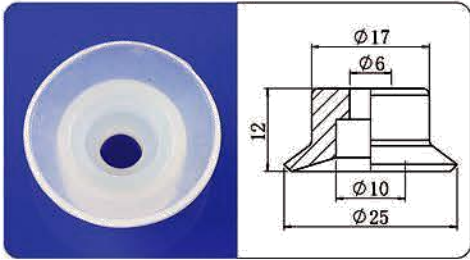

VP-25R

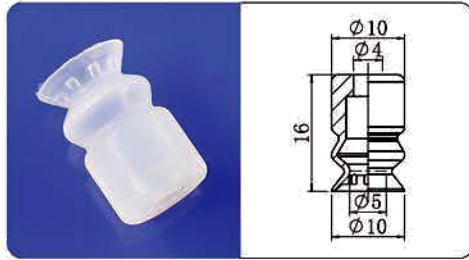

VP-10B

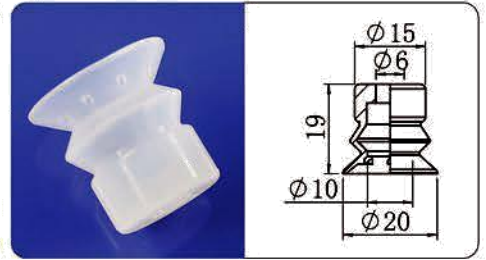

VP-20B

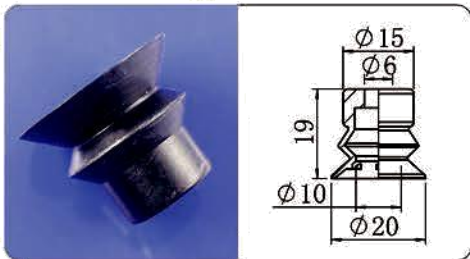

VP-20B

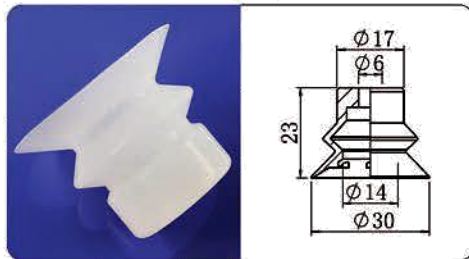

VP-30B

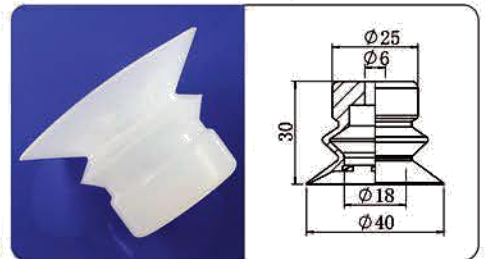

VP-40B

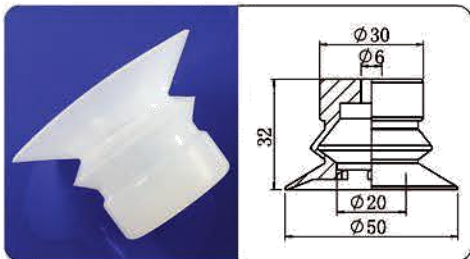

VP-50B

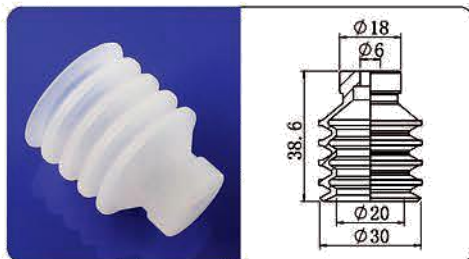

VP-30W

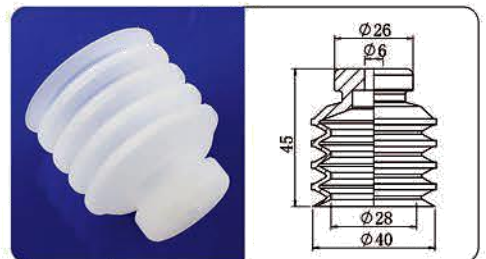

VP-40W

○有信吸盘系列
S:白色 硅橡胶
R:红色 硅橡胶
多种款式 非标可定做

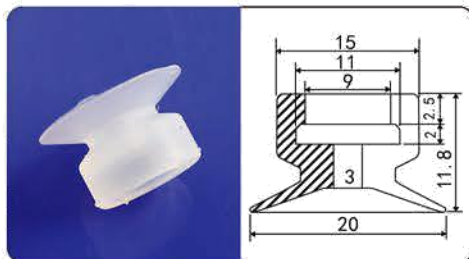

YX-20S

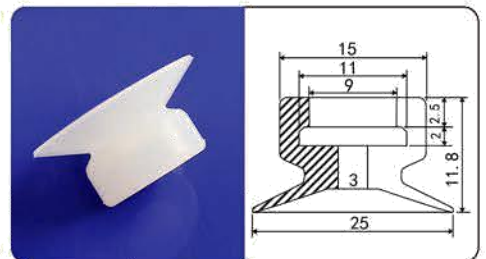

YX-25S

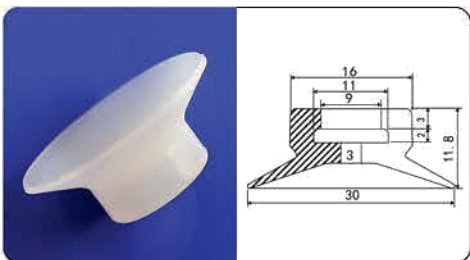

YX-30S

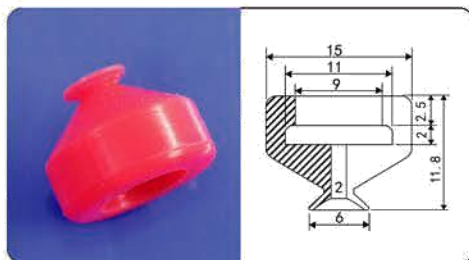

YX-6R

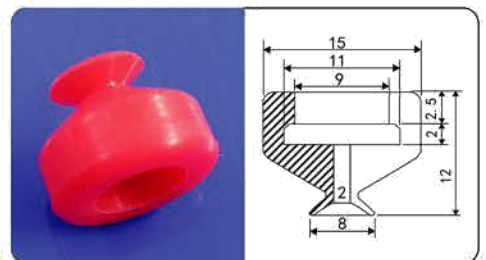

YX-8R

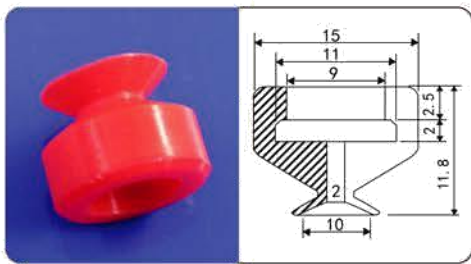

YX-10R

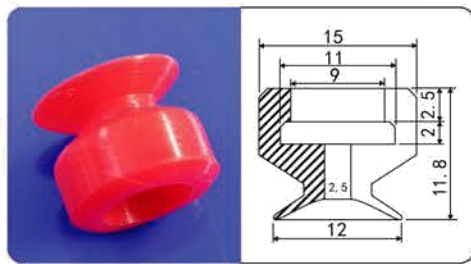

YX-12R

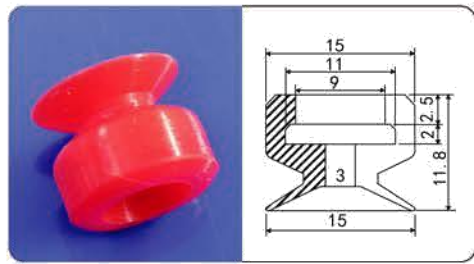

YX-15R

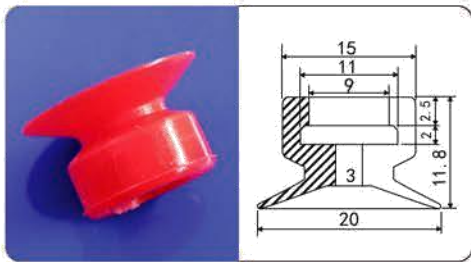

YX-20R

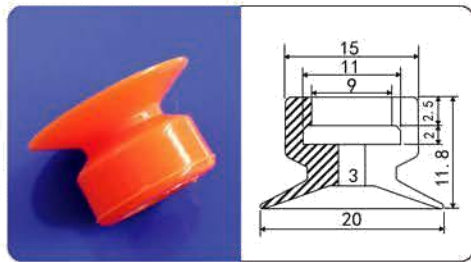

YX-20橙

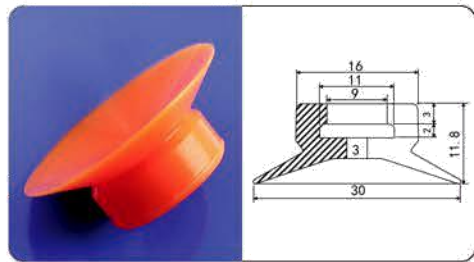

YX-30橙

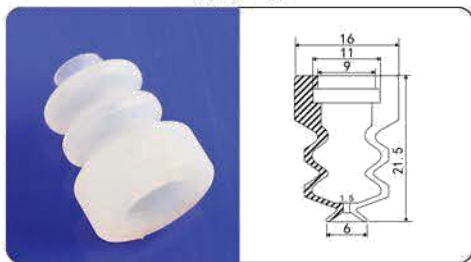

YX-6-3S

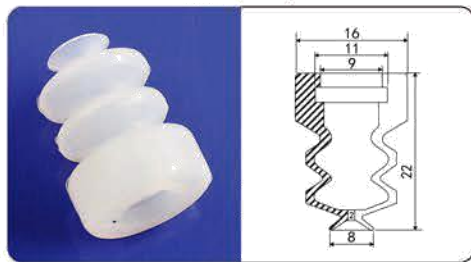

YX-8-3S

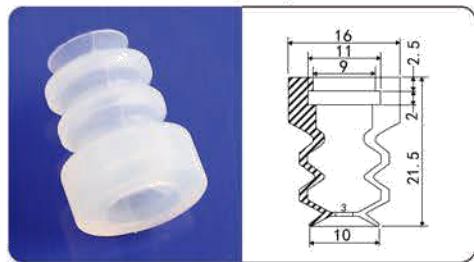

YX-10-3S

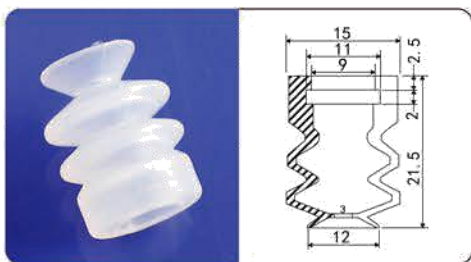

YX-12-3S

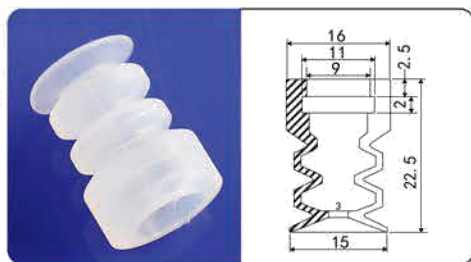

YX-15-3S

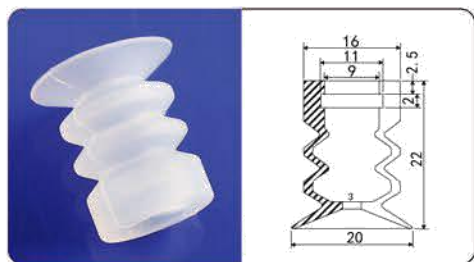

YX-20-3S

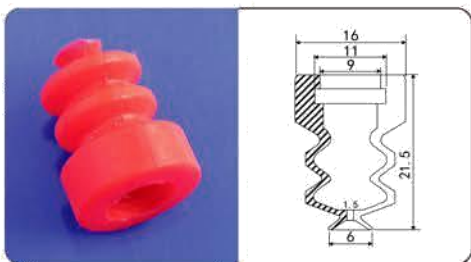

YX-6-3R

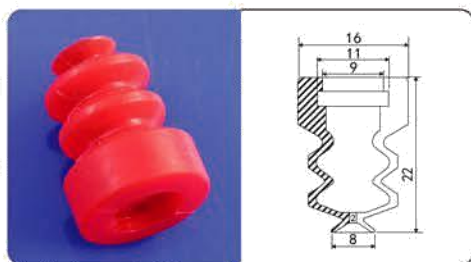

YX-8-3R

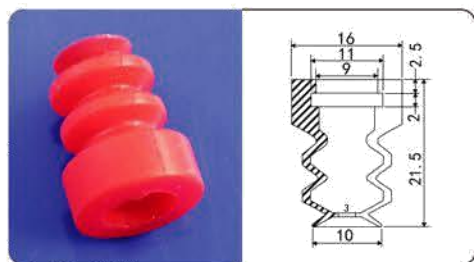

YX-10-3R

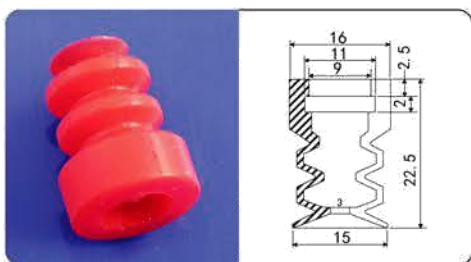

YX-15-3R

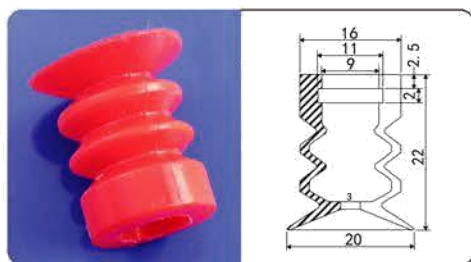

YX-20-3R

型号齐全 非标可定做

○条型吸盘系列

S:白色 硅橡胶

N:黑色 丁腈橡胶

多种款式 非标可定做

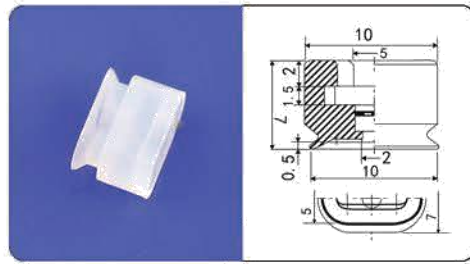

W5-L10S

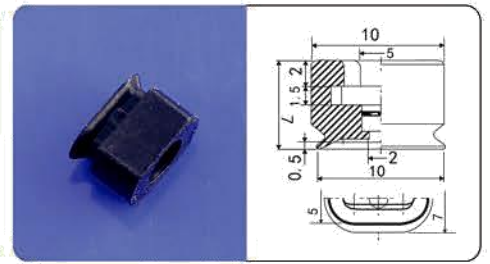

W5-L10N

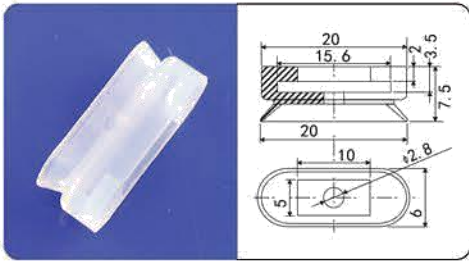

W6-L20S

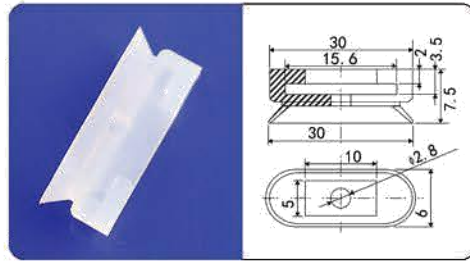

W6-L30S

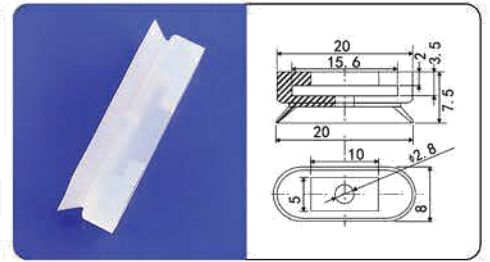

W8-L20S

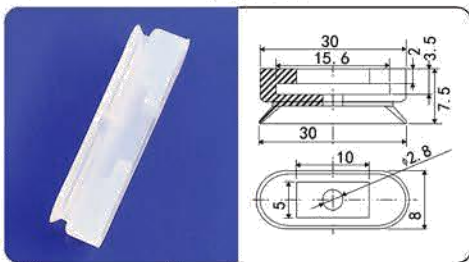

W8-L30S

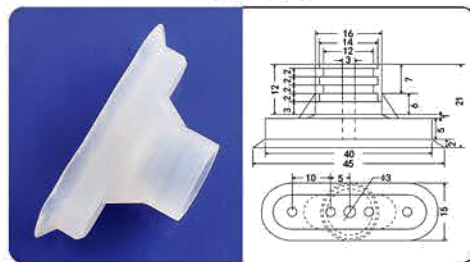

W15-L45S

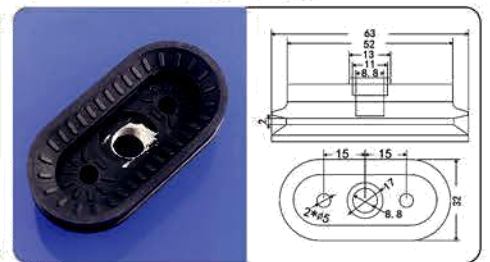

W30-L60N

○派亚博吸盘系列

S:白色 硅橡胶

N:黑色 丁腈橡胶

R:红色 硅橡胶

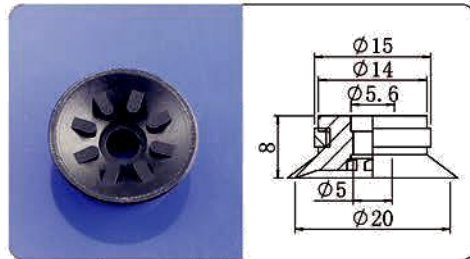

F20-2N

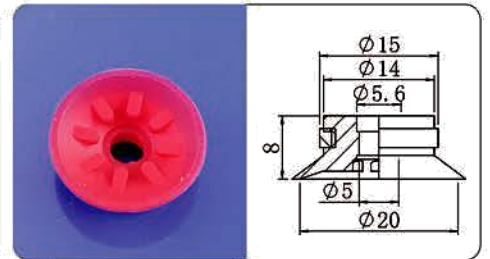

F20-2R

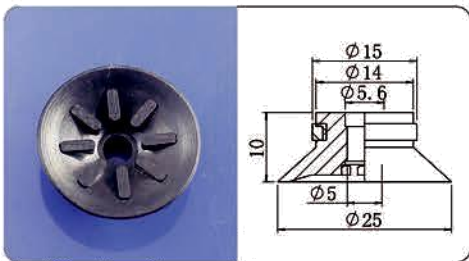

F25-2N

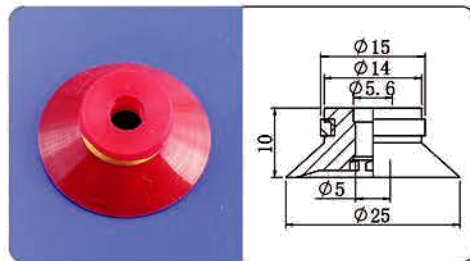

F25-2R

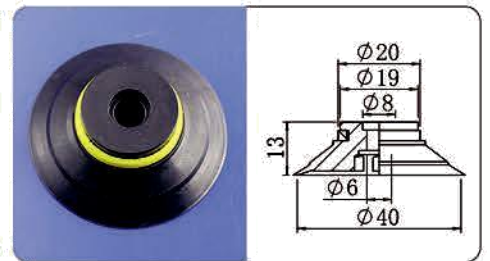

F40-2N

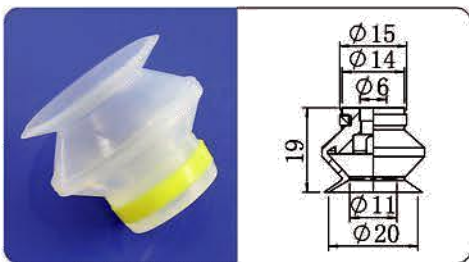

B-20S

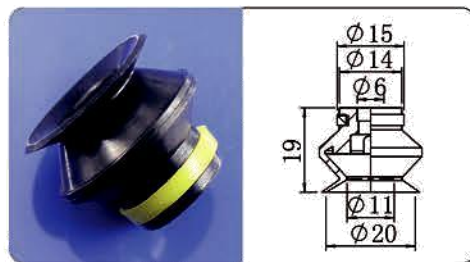

B-20N

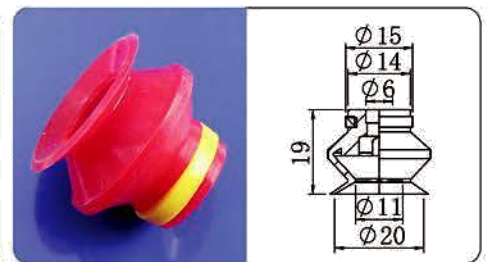

B-20R

海绵无痕吸盘系列



海绵真空吸盘(粗糙面专用)



无痕真空吸盘

非标
可定做

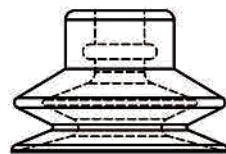

○海绵吸盘部分型号(以下产品尺寸图为未加海绵吸盘尺寸,可定做)

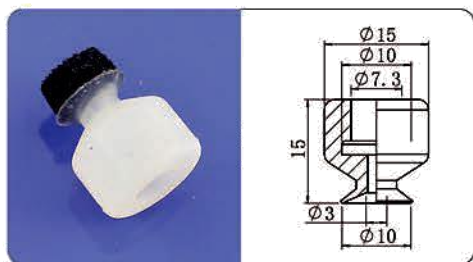

HSP-10

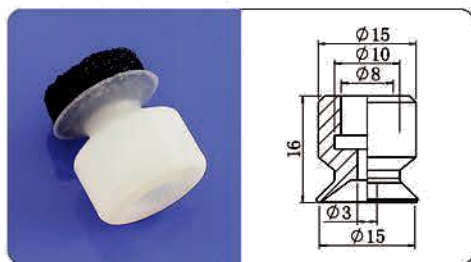

HSP-15

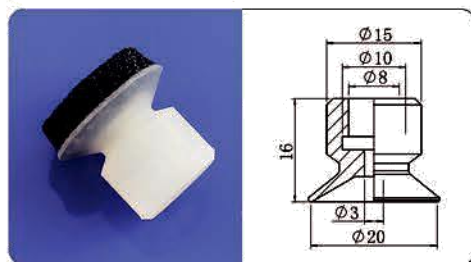

HSP-20

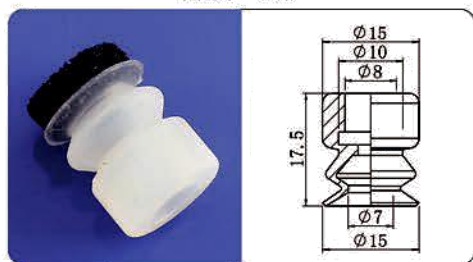

HSP-15-2

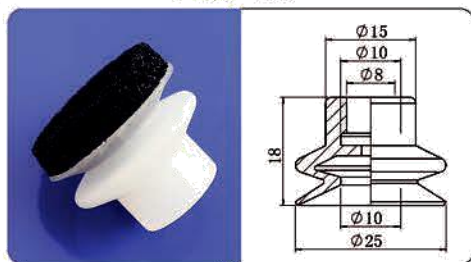

HSP-25-2

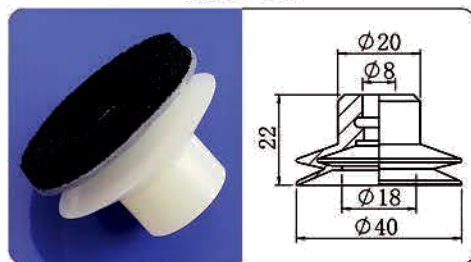

HSP-40-2

○无痕吸盘部分型号(以下产品尺寸图为未加海绵吸盘尺寸,可定做)

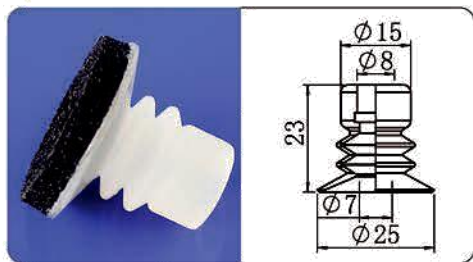

HSP-25-3

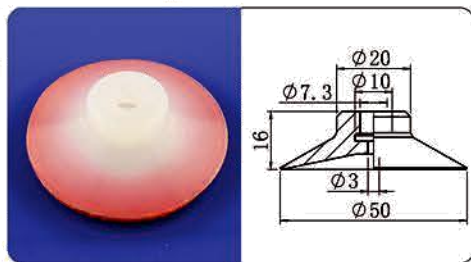

无痕HSP-50

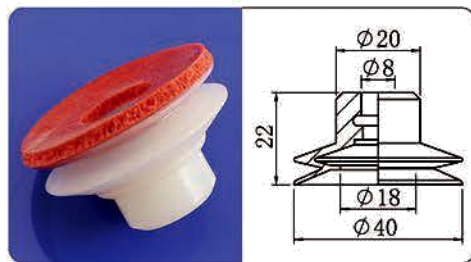

无痕HSP-40-2

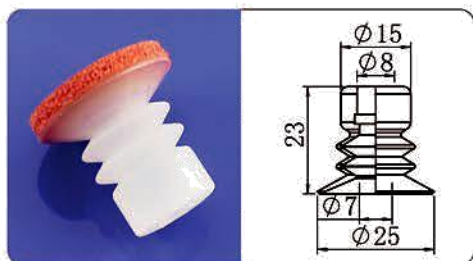

无痕HSP-25-3

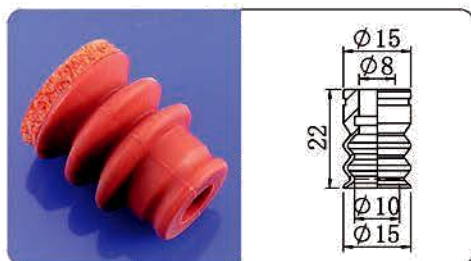

星塔无痕SR-15-3

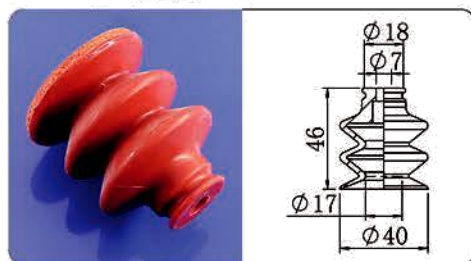

星塔无痕SR-40-3

真空吸盘型号齐全 非标可定做

真空吸盘系列

大头侧通金具系列



非标可定制

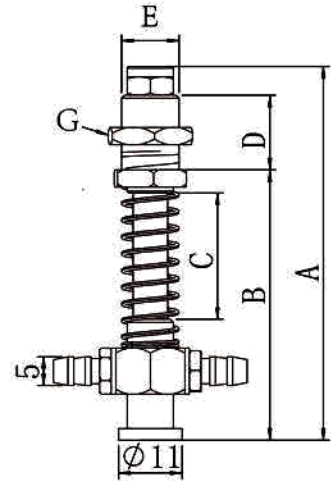

金具系列型号表示方法

TL—M10—L65—11—KB—00

T: Y系列金具 安装连接方式:
L: 真空方向 M10*1.0 M12*1.0
L垂直 S水平
金具总长度
配吸盘 小头7系列 大头11系列
空表示可旋转 接头--空为标准
K表示不可旋转 00表示特殊
空为标准螺牙
B位加长安装螺牙

大头直通金具系列



非标可定制

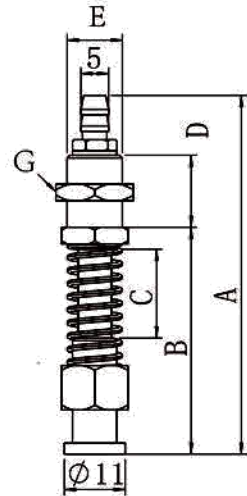

金具系列型号表示方法

TS—M10—L65—11—KB—00

T: Y系列金具 安装连接方式:
L: 真空方向 M10*1.0 M12*1.0
L垂直 S水平
金具总长度
配吸盘 小头7系列 大头11系列
空表示可旋转 接头--空为标准
K表示不可旋转 00表示特殊
空为标准螺牙
B位加长安装螺牙

大头侧通M10金具系列

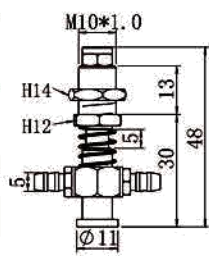

TL-M10-L48-11

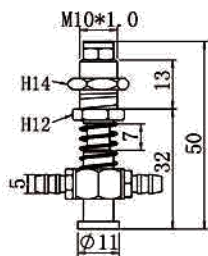

TL-M10-L50-11

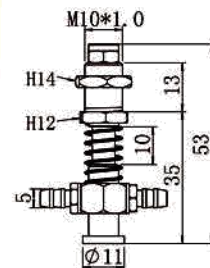

TL-M10-L53-11

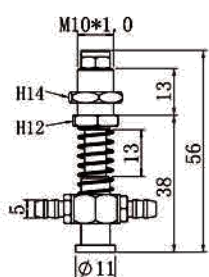

TL-M10-L56-11

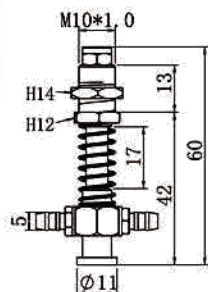

TL-M10-L60-11

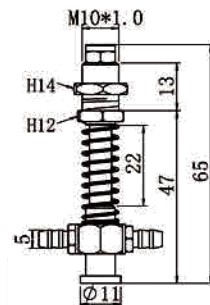

TL-M10-L65-11

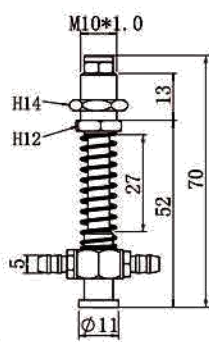

TL-M10-L70-11

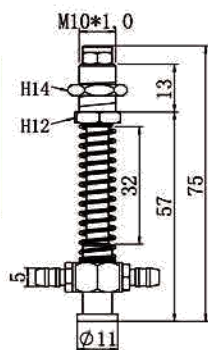

TL-M10-L75-11

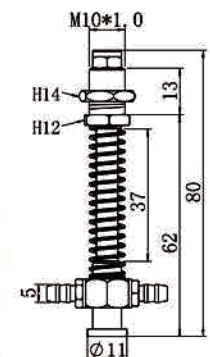

TL-M10-L80-11

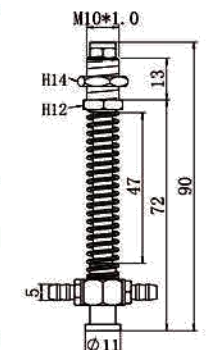

TL-M10-L90-11

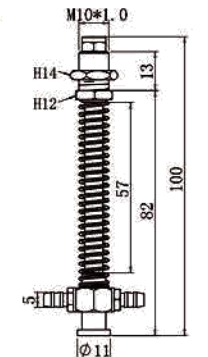

TL-M10-L100-11

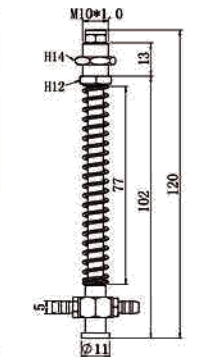

TL-M10-L120-11

吸盘金具系列

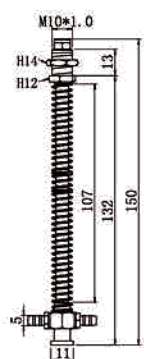

TL-M10-L150-11

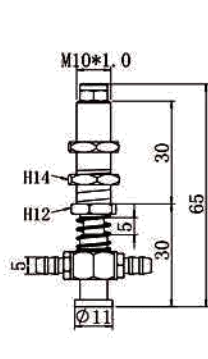

TL-M10-L65-11B

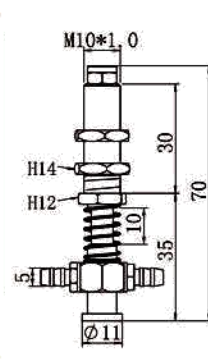

TL-M10-L70-11B

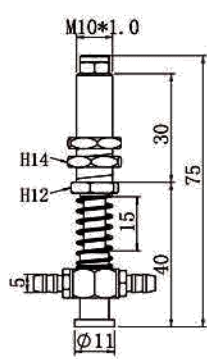

TL-M10-L75-11B

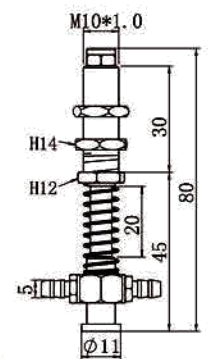

TL-M10-L80-11B

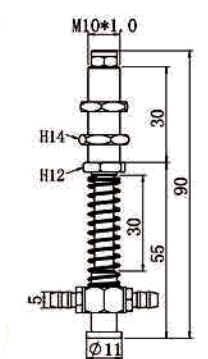

TL-M10-L90-11B

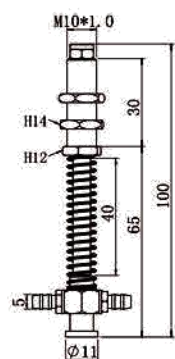

TL-M10-L100-11B

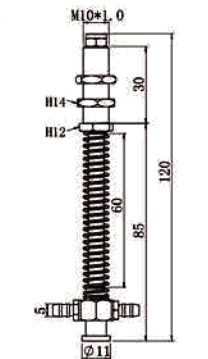

TL-M10-L120-11B

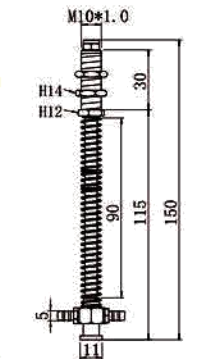

TL-M10-L150-11B

大头侧通M12金具系列

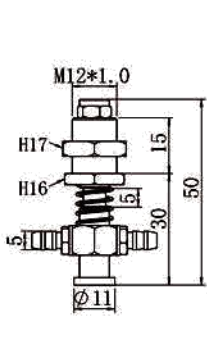

TL-M12-L50-11

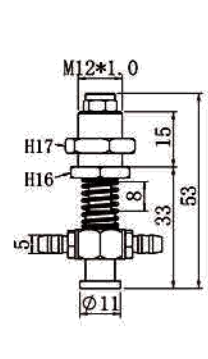

TL-M12-L53-11

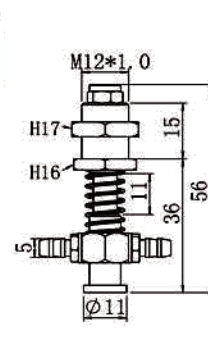

TL-M12-L56-11

吸盘金具系列

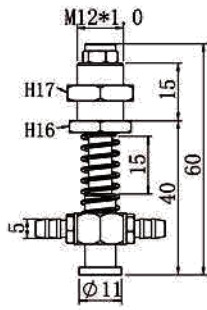

TL-M12-L60-11

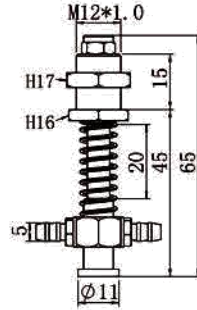

TL-M12-L65-11

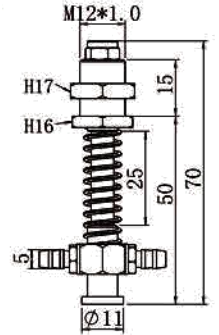

TL-M12-L70-11

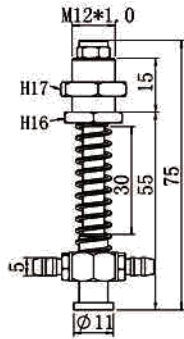

TL-M12-L75-11

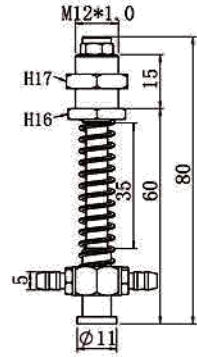

TL-M12-L80-11

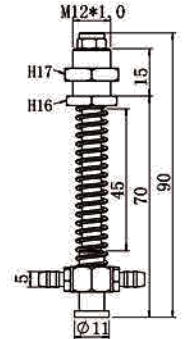

TL-M12-L90-11

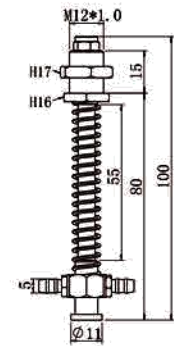

TL-M12-L100-11

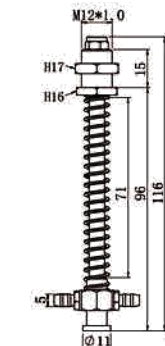

TL-M12-L116-11

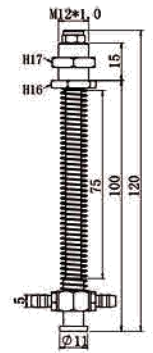

TL-M12-L120-11

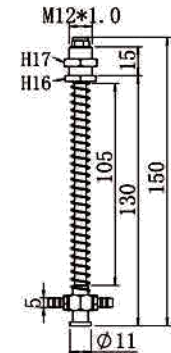

TL-M12-L150-11

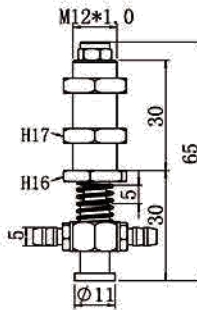

TL-M12-L65-11B

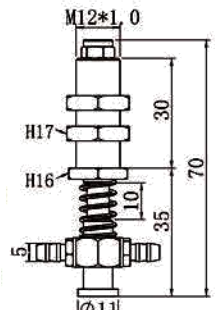

TL-M12-L170-11B

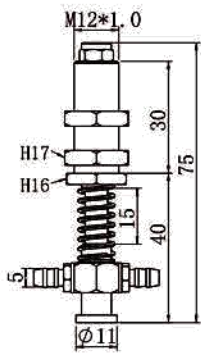

TL-M12-L75-11B

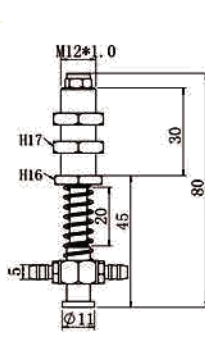

TL-M12-L80-11B

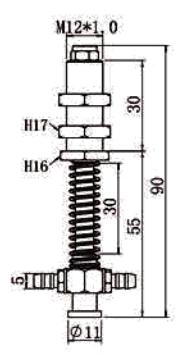

TL-M12-L90-11B

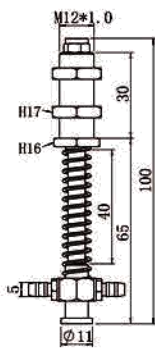

TL-M12-L100-11B

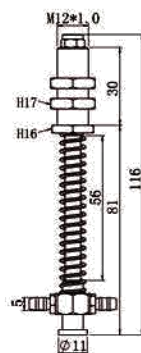

TL-M12-L116-11B

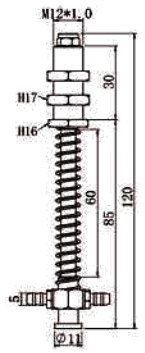

TL-M12-L120-11B

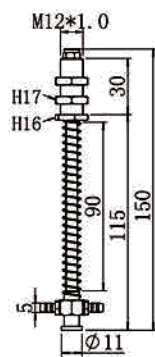

TL-M12-L150-11B

型号齐全 非标可定做

大头直通M10金具系列

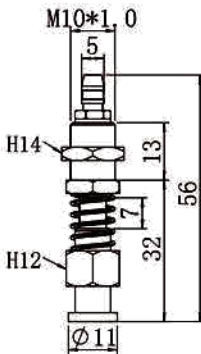

TS-M10-L56-11

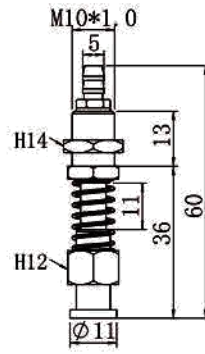

TS-M10-L60-11

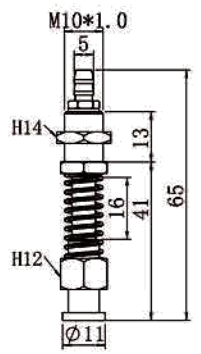

TS-M10-L65-11

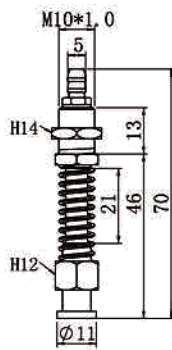

TS-M10-L70-11

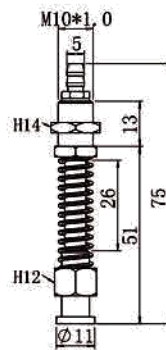

TS-M10-L75-11

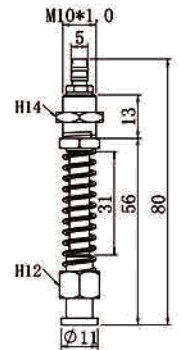

TS-M10-L80-11

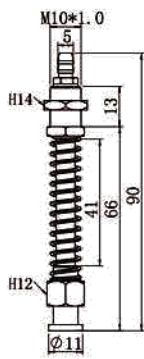

TS-M10-L90-11

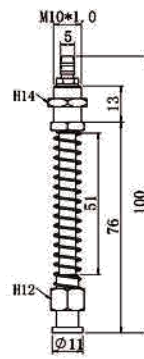

TS-M10-L100-11

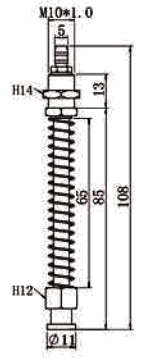

TS-M10-L108-11

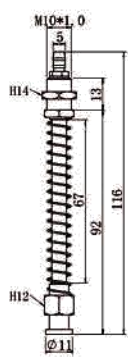

TS-M10-L116-11

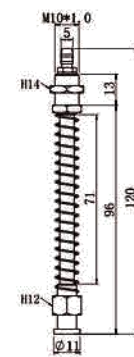

TS-M10-L120-11

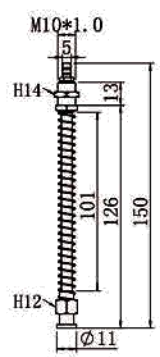

TS-M10-L150-11

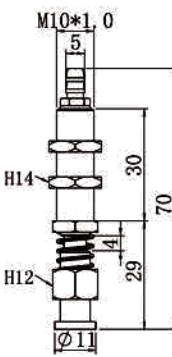

TS-M10-L70-11B

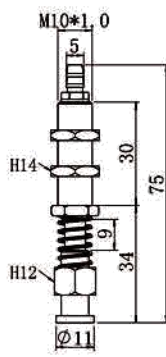

TS-M10-L75-11B

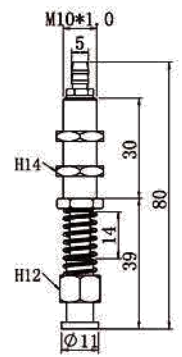

TS-M10-L80-11B

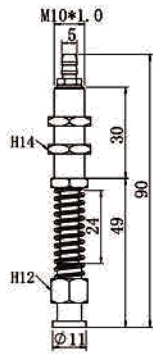

TS-M10-L90-11B

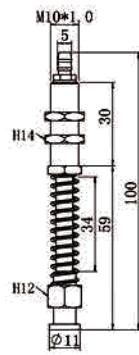

TS-M10-L100-11B

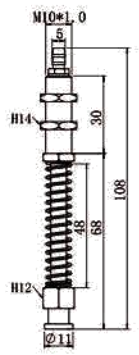

TS-M10-L108-11B

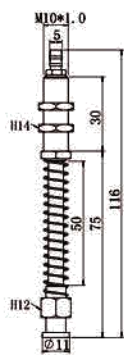

TS-M10-L116-11B

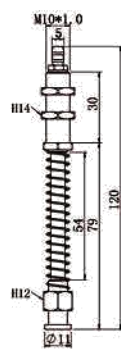

TS-M10-L120-11B

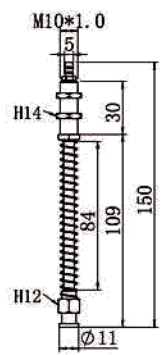

TS-M10-L150-11B

大头直通M12金具系列

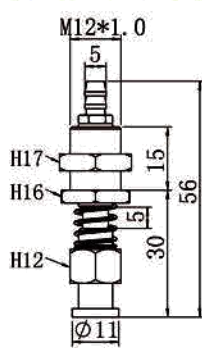

TS-M12-L56-11

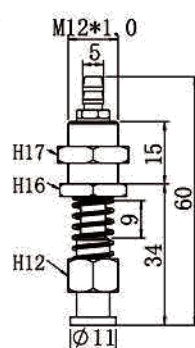

TS-M12-L60-11

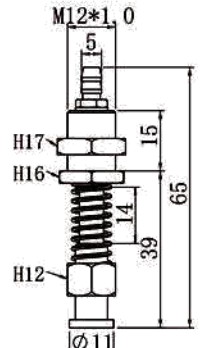

TS-M12-L65-11

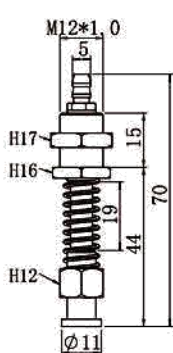

TS-M12-L70-11

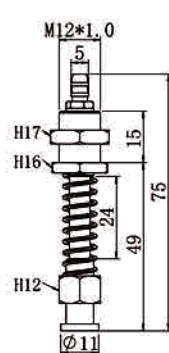

TS-M12-L75-11

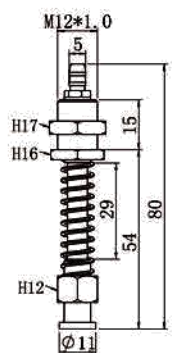

TS-M12-L80-11

吸盘金具系列

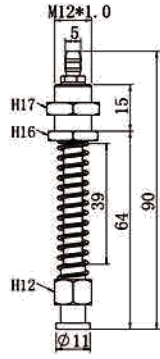

TS-M12-L90-11

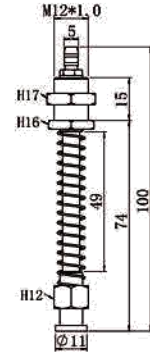

TS-M12-L100-11

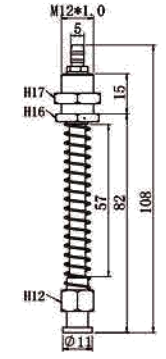

TS-M12-L108-11

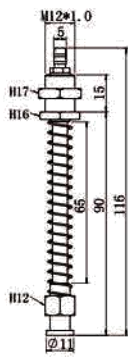

TS-M12-L116-11

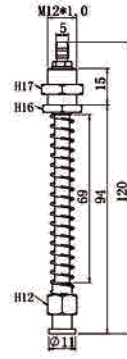

TS-M12-L120-11

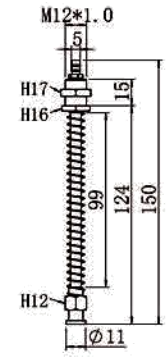

TS-M12-L150-11

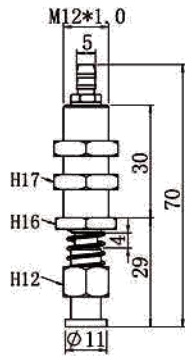

TS-M12-L70-11B

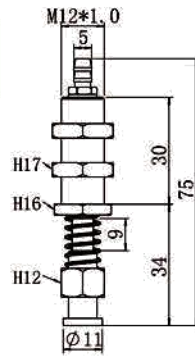

TS-M12-L75-11B

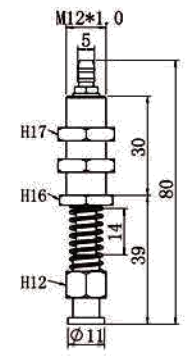

TS-M12-L80-11B

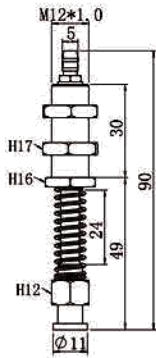

TS-M12-L90-11B

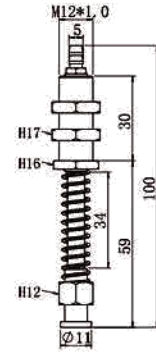

TS-M12-L100-11B

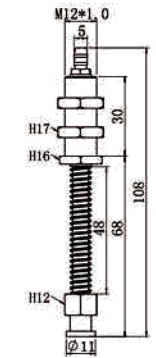

TS-M12-L108-11B

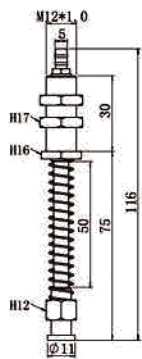

TS-M12-L116-11B

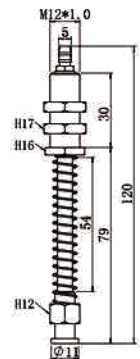

TS-M12-L120-11B

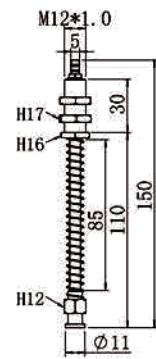

TS-M12-L150-11B

小头侧通金具系列



非标可定制

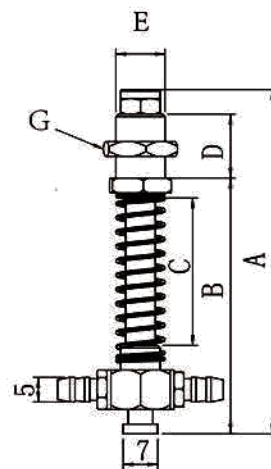

金具系列型号表示方法

TL—M10—L65—7—KB—00

T: Y系列金具 安装连接方式:

L: 真空方向 M10*1.0 M12*1.0

L垂直 S水平

金具总长度

配吸盘 小头7系列

大头11系列

空表示可旋转

K表示不可旋转

空为标准螺牙

B位加长安装螺牙

接头--空为标准

00表示特殊

小头侧通M10金具系列

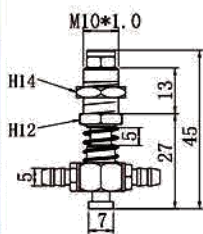

TL-M10-L45-7

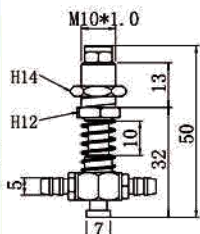

TL-M10-L50-7

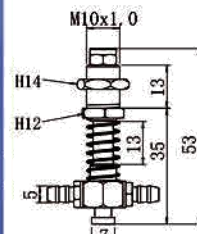

TL-M10-L53-7

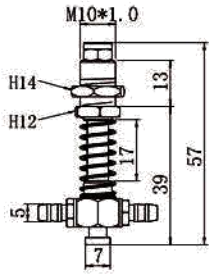

TL-M10-L56-7

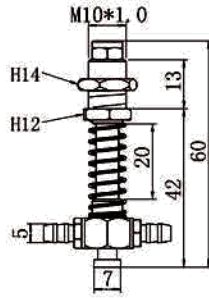

TL-M10-L60-7

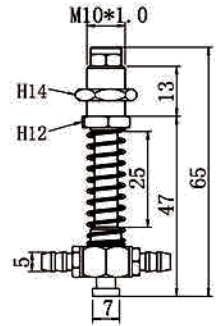

TL-M10-L65-7

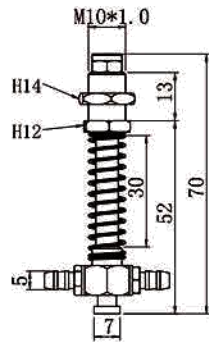

TL-M10-L70-7

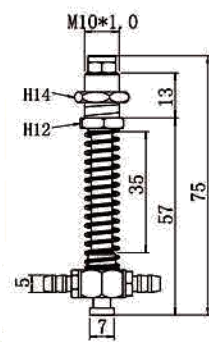

TL-M10-L75-7

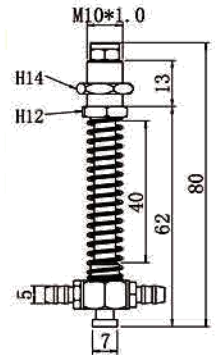

TL-M10-L80-7

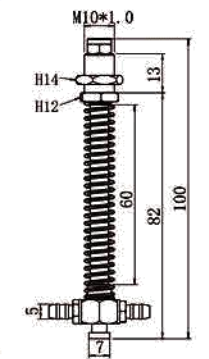

TL-M10-L100-7

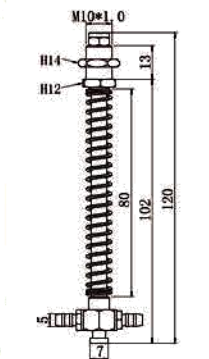

TL-M10-L120-7

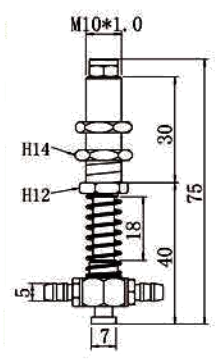

TL-M10-L75-7B

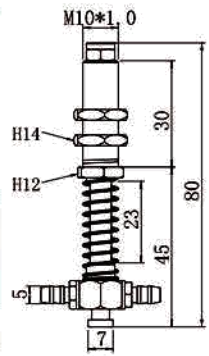

TL-M10-L80-7B

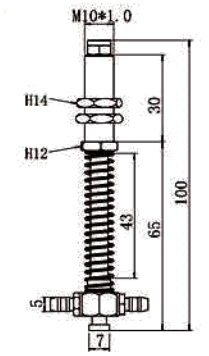

TL-M10-L100-7B

型号齐全 非标可定做

小头侧通M12金具系列

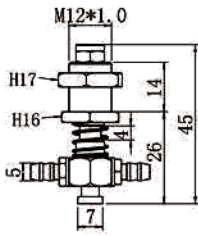

TL-M12-L45-7

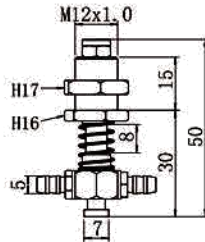

TL-M12-L50-7

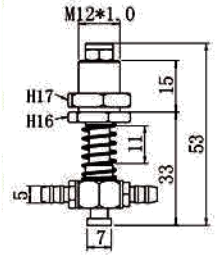

TL-M12-L53-7

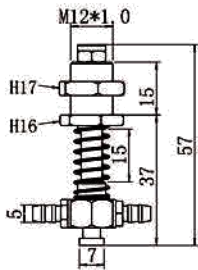

TL-M12-L57-7

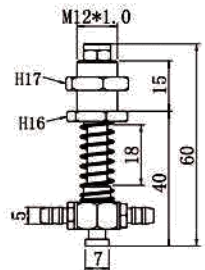

TL-M12-L60-7

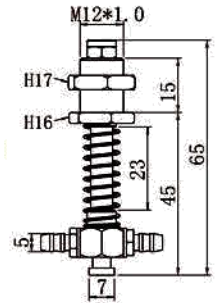

TL-M12-L65-7

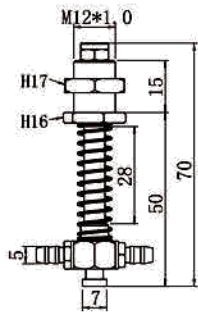

TL-M12-L70-7

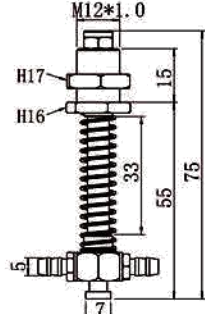

TL-M12-L75-7

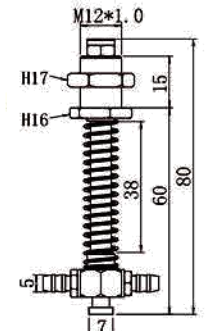

TL-M12-L80-7

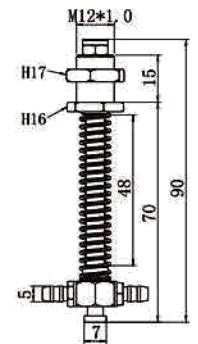

TL-M12-L90-7

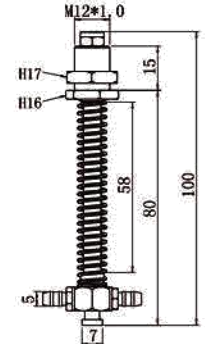

TL-M12-L100-7

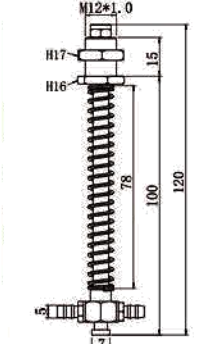

TL-M12-L120-7

吸盘金具系列

小头直通M10金具系列

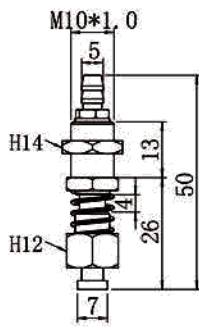

TS-M10-L50-7

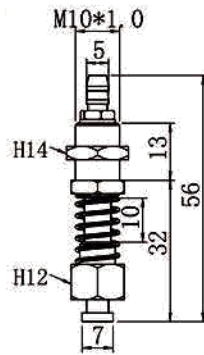

TS-M10-L56-7

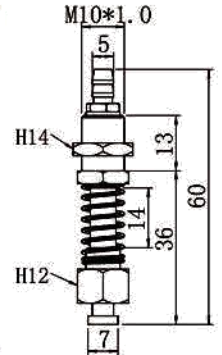

TS-M10-L60-7

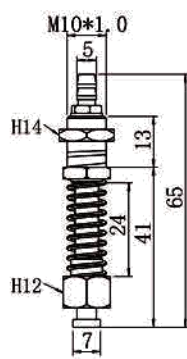

TS-M10-L65-7

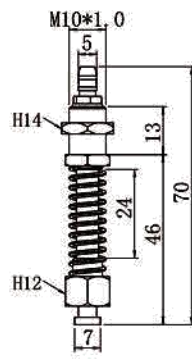

TS-M10-L70-7

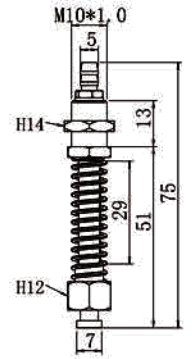

TS-M10-L75-7

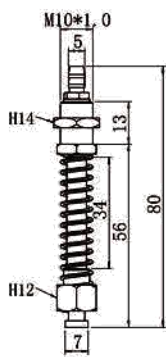

TS-M10-L80-7

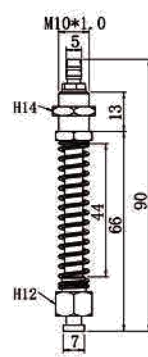

TS-M10-L90-7

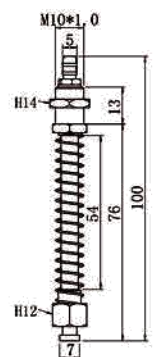

TS-M10-L100-7

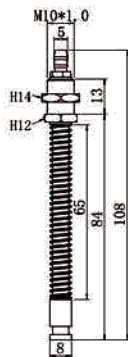

TS-M10-L108-7

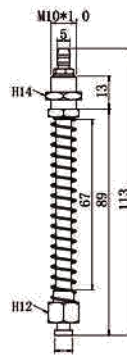

TS-M10-L113-7

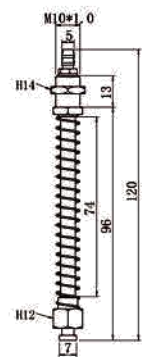

TS-M10-L120-7

吸盘金具系列

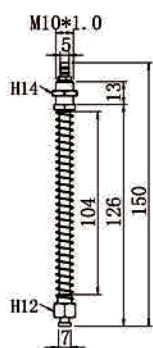

TS-M10-L150-7

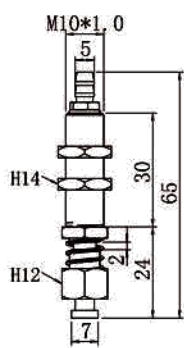

TS-M10-L65-7B

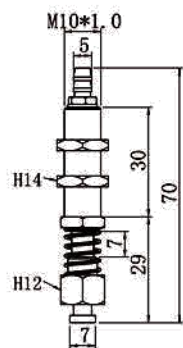

TS-M10-L70-7B

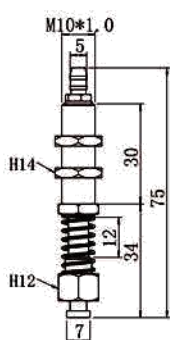

TS-M10-L75-7B

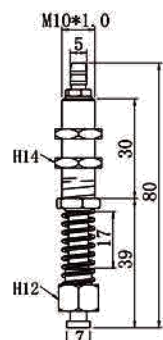

TS-M10-L80-7B

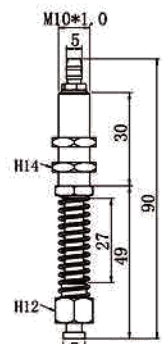

TS-M10-L90-7B

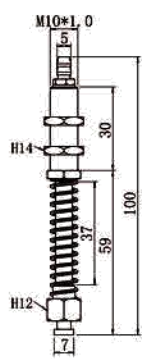

TS-M10-L100-7B

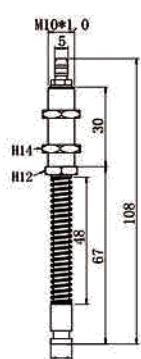

TS-M10-L108-8B

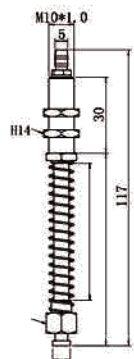

TS-M10-L116-7B

小头侧直通M12金具系列

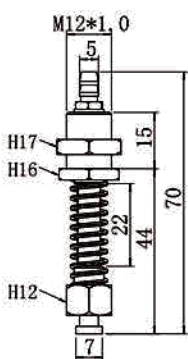

TS-M12-L70-7

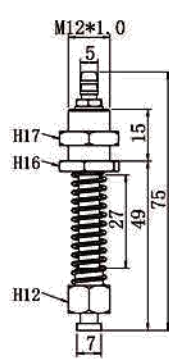

TS-M12-L75-7

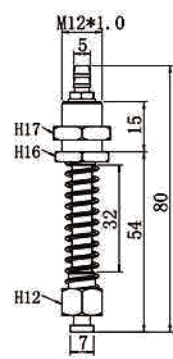

TS-M12-L80-7

吸盘金具系列

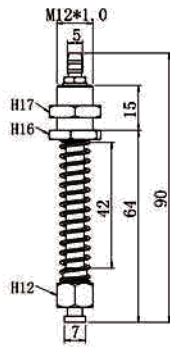

TS-M12-L90-7

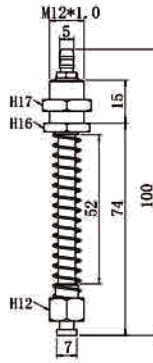

TS-M12-L100-7

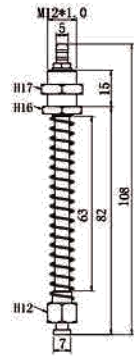

TS-M12-L108-7

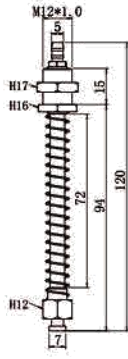

TS-M12-L120-7

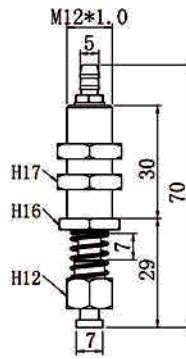

TS-M12-L70-7B

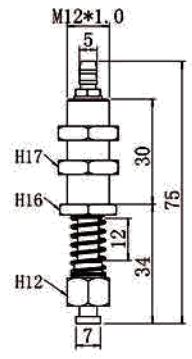

TS-M12-L75-7B

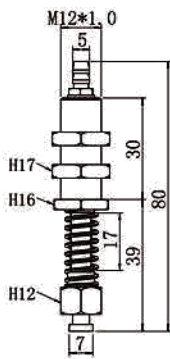

TS-M12-L80-7B

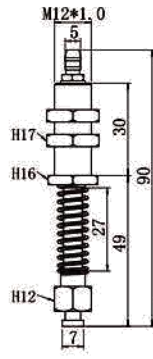

TS-M12-L90-7B

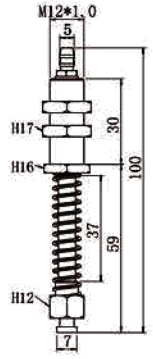

TS-M12-L100-7B

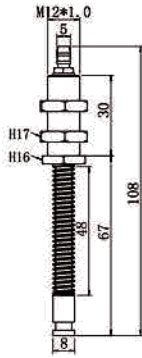

TS-M12-L108-8B

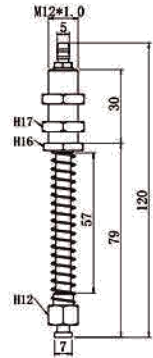

TS-M12-L120-7B

型号齐全 非标可定做

大头不旋转金具系列



非标
可定制

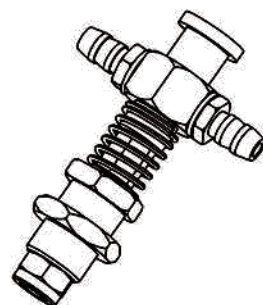

金具系列型号表示方法

TL—M10—L65—11—KB—00

T: Y系列金具 安装连接方式: 配吸盘 小头7系列 空表示可旋转 接头--空为标准
 L: 真空方向 M10*1.0 M12*1.0 大头11系列 K表示不可旋转 00表示特殊
 L垂直 S水平 金具总长度 空为标准螺牙 B位加长安装螺牙

吸盘金具系列

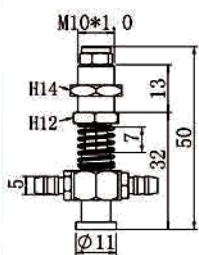

TL-M10-L50-11K

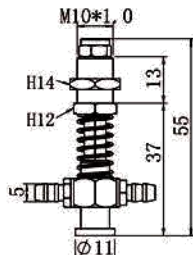

TL-M10-L55-11K

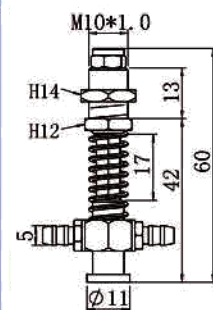

TL-M10-L60-11K

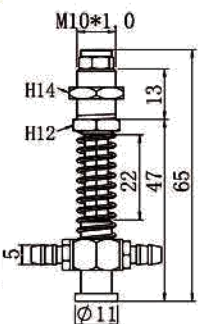

TL-M10-L65-11K

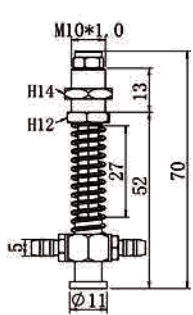

TL-M10-L70-11K

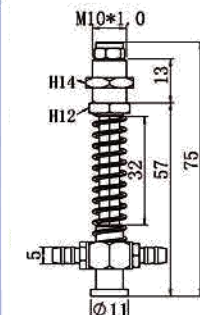

TL-M10-L75-11K

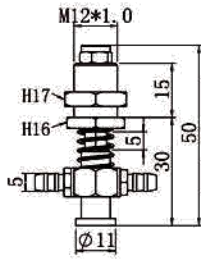

TL-M12-L50-11K

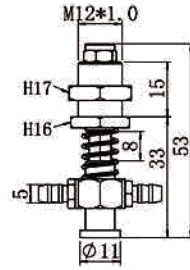

TL-M12-L53-11K

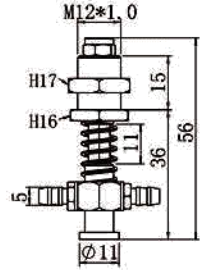

TL-M12-L56-11K

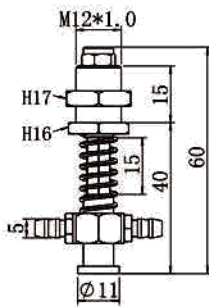

TL-M12-L60-11K

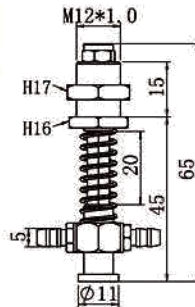

TL-M12-L65-11K

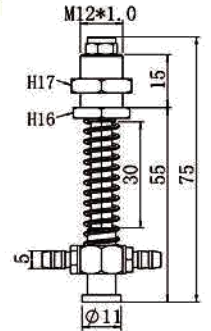

TL-M12-L70-11K

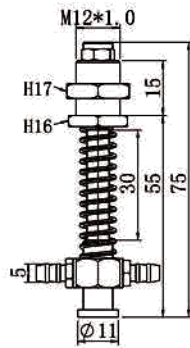

TL-M12-L75-11K

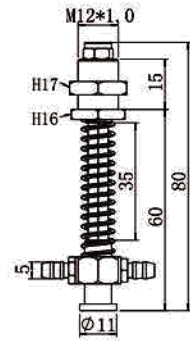

TL-M12-L80-11K

型号齐全 非标可定做

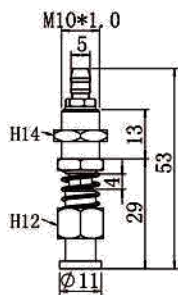

TS-M10-L53-11K

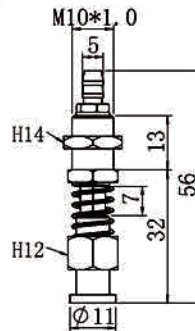

TS-M10-L56-11K

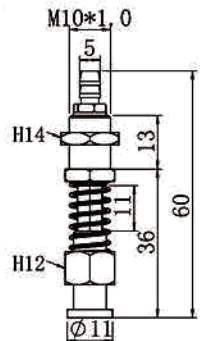

TS-M10-L60-11K

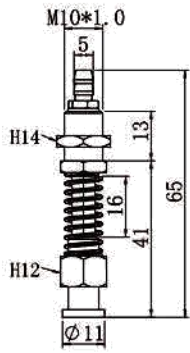

TS-M10-L65-11K

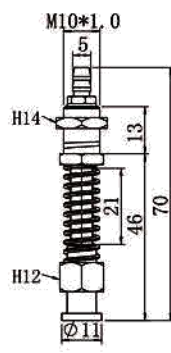

TS-M10-L70-11K

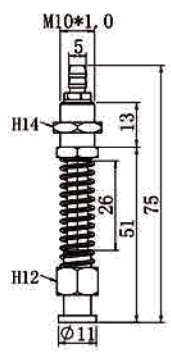

TS-M10-L75-11K

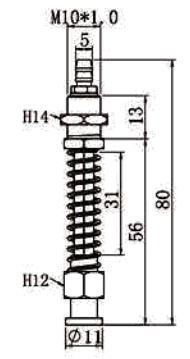

TS-M10-L80-11K

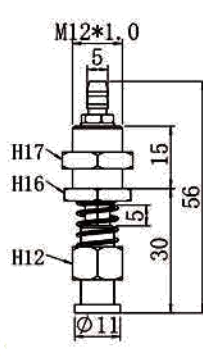

TS-M12-L56-11K

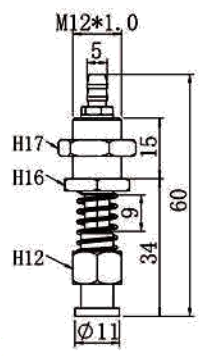

TS-M12-L60-11K

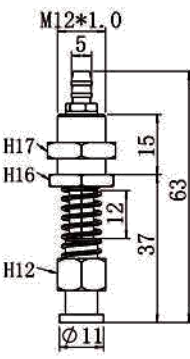

TS-M12-L63-11K

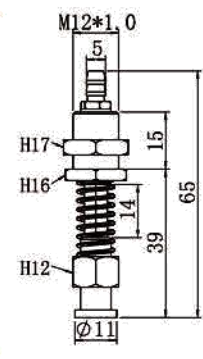

TS-M12-L65-11K

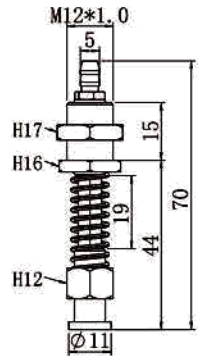

TS-M12-L70-11K

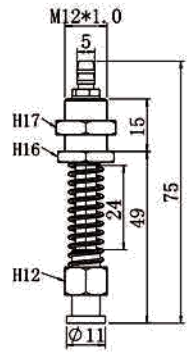

TS-M12-L75-11K

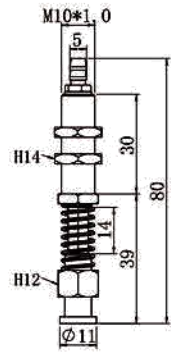

TS-M10-L80-11BK

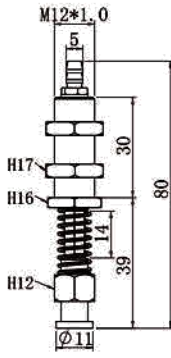

TS-M12-L80-11BK

吸盘金具系列

小头不旋转金具系列



非标可定制

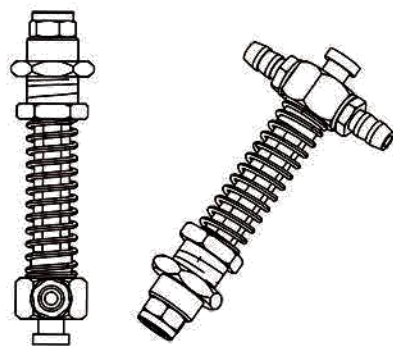

金具系列型号表示方法

TL—M10—L65—7—KB—00

T: Y系列金具 安装连接方式: M10*1.0 M12*1.0
 L: 真空方向 L垂直 S水平
 金具总长度
 配吸盘 小头7系列 大头11系列
 空表示可旋转 接头--空为标准
 K表示不可旋转 00表示特殊
 空为标准螺牙
 B位加长安装螺牙

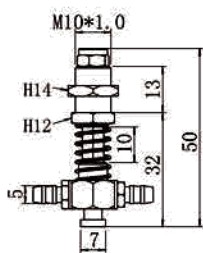

TL-M10-L50-7K

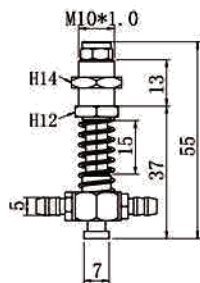

TL-M10-L55-7K

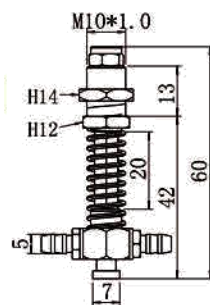

TL-M10-L60-7K

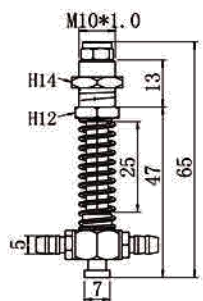

TL-M10-L65-7K

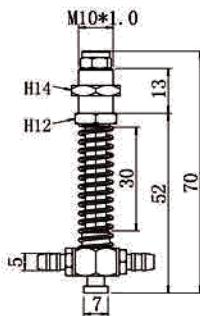

TL-M10-L70-7K

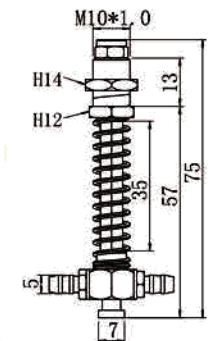

TL-M10-L75-7K

小头直通不旋转金具系列

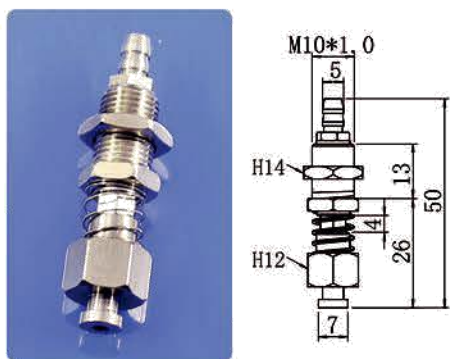

TS-M10-L50-7K

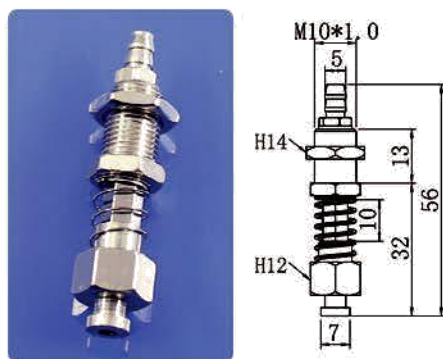

TS-M10-L56-7K

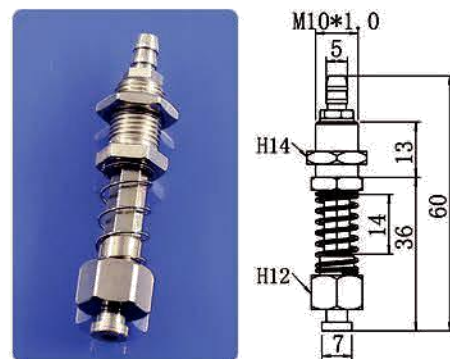

TS-M10-L60-7K

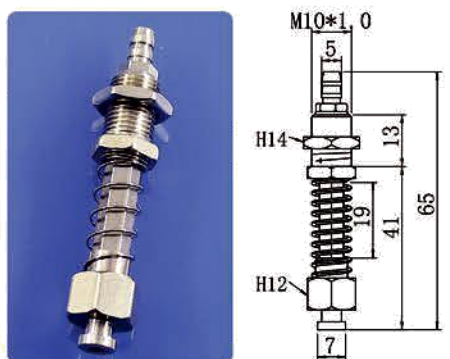

TS-M10-L65-7K

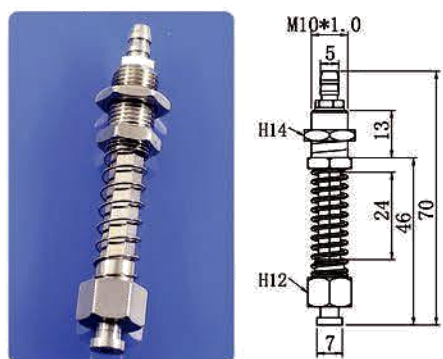

TS-M10-L70-7K

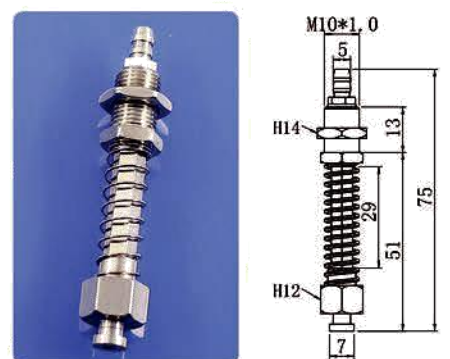

TS-M10-L75-7K



TS-M12-L53-7K

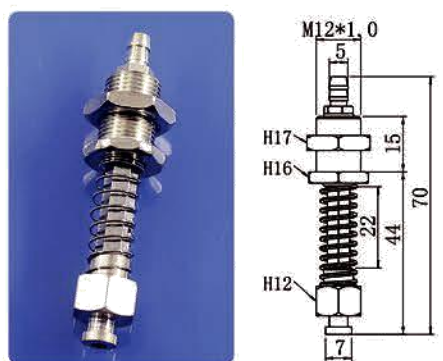

TS-M12-L70-7K

型号齐全 非标可定做

迷你金具系列



非标可定制

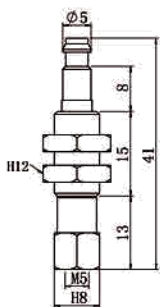
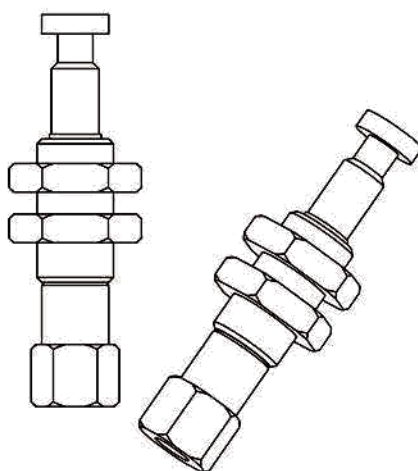

41长尖头(铁镀镍)

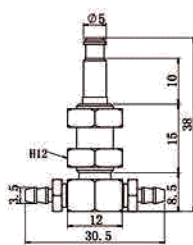

T-M8-L38尖头(镀镍)

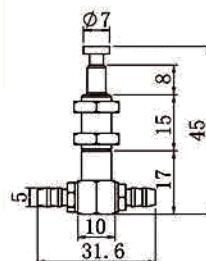

T-M8-L45尖头(铜)

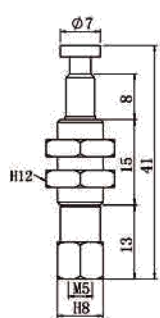

41长平头(铜)

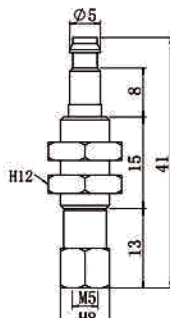

41长尖头(铜)

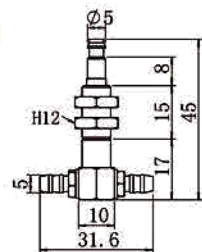

T-M8-L45平头(铜)

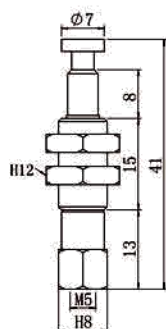

41长平头(镀镍)

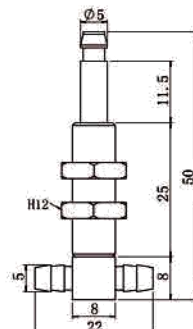

T-M8-L50尖头(镀镍)

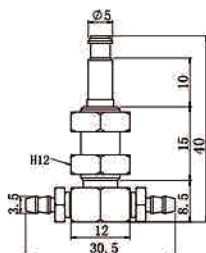

T-M8-L40尖头

吸盘金具系列

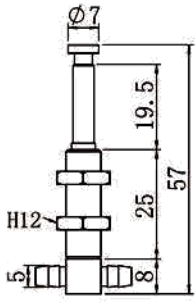

T-M8-L56平头(镀镍)

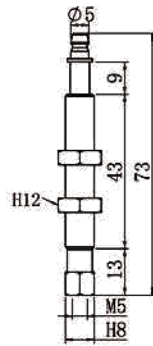

73长尖头(镀镍)

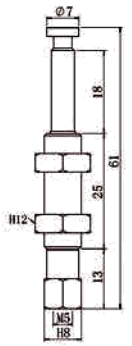

M8-L61长平头

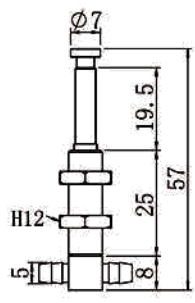

T-M8-L56尖头(镀镍)

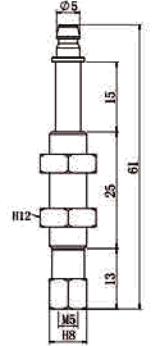

M8-L61长尖头

型号齐全 非标可定做

吸盘金具系列

妙德金具系列



非标可定制

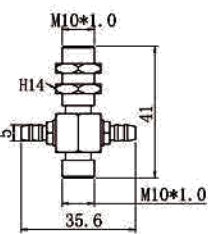
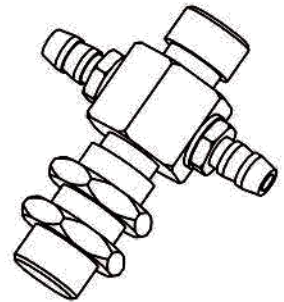
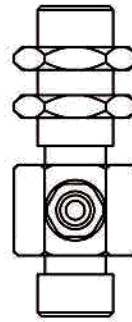

M10-M10-L43 1.0细牙

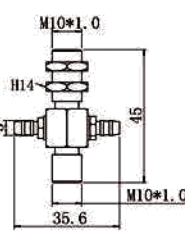

M10-M10-L45 1.0细牙

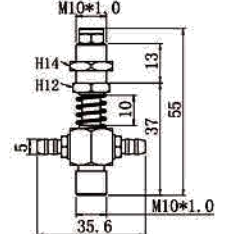

M10-M10-L53 1.0细牙

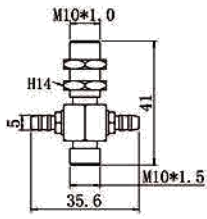

M10-M10-L43 1.5粗牙

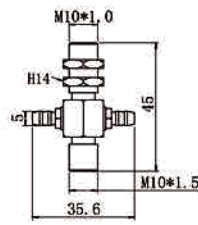

M10-M10-L45 1.5粗牙

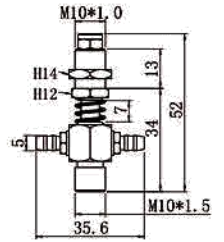

M10-M10-L53 1.5粗牙

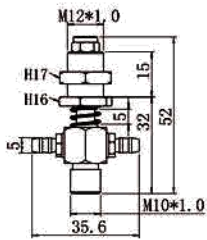

M10-M12-L53 1.0细牙

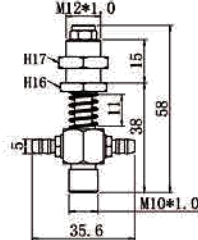

M10-M12-L58 1.0细牙

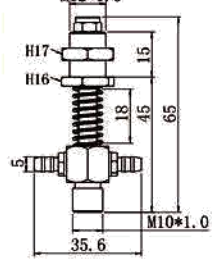

M10-M12-L65 1.0细牙

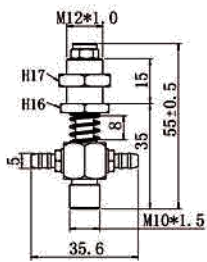

M10-M12-L53 1.5粗牙

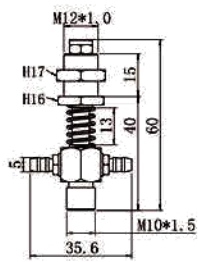

M10-M12-L60 1.5粗牙

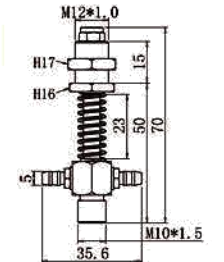

M10-M12-L70 1.5粗牙

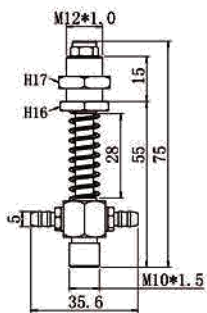

M10-M12-L75 1.5粗牙

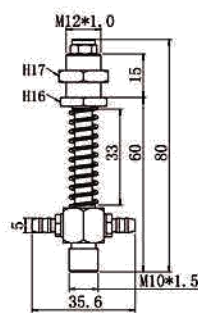

M10-M12-L80 1.5粗牙

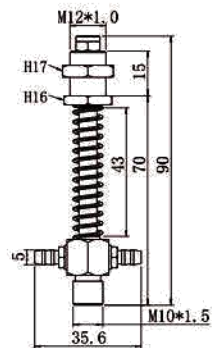

M10-M12-L90 1.5粗牙

抱具夹片系列

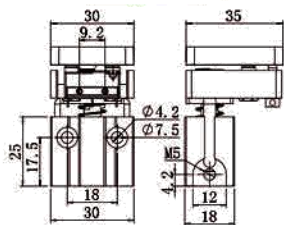

1205WD抱具

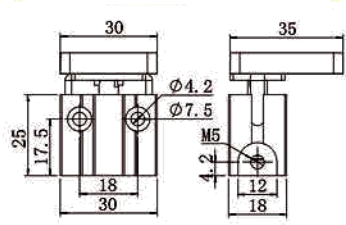

1205PT抱具

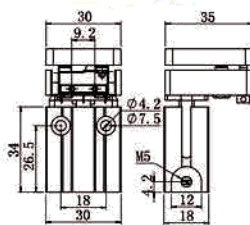
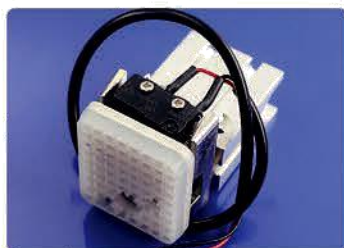

1210WD抱具

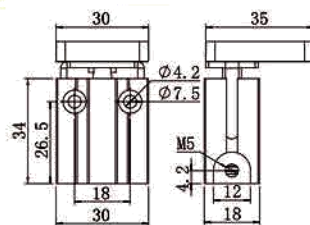

1210PT抱具

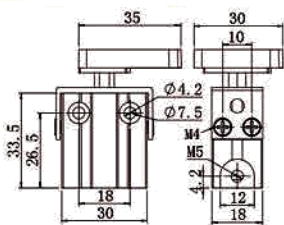

1210PTA抱具

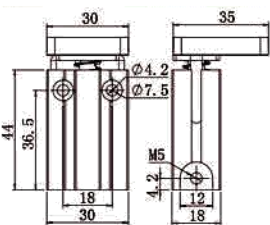

1210CH抱具

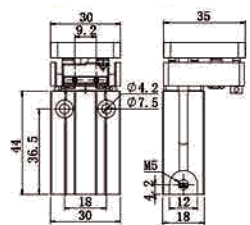

1218WD抱具

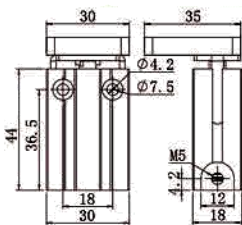

1218PT抱具

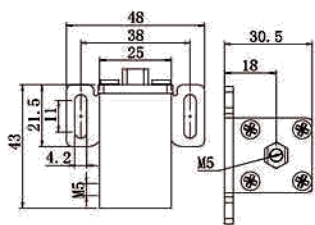

1815抱具气缸(扁六角)

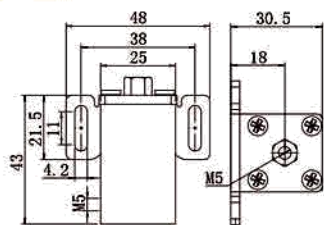

1815抱具气缸(椭圆)

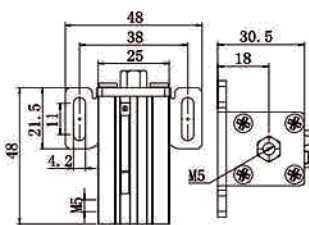

1815CH抱具(带磁)

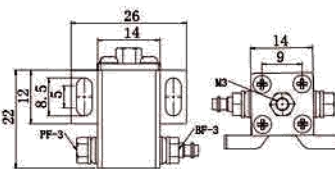

UMCD-5六角杆抱具

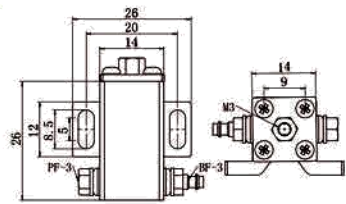

UMCD-10六角杆抱具

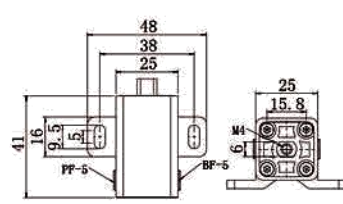

MCD-10大角抱具

抱具夹片系列

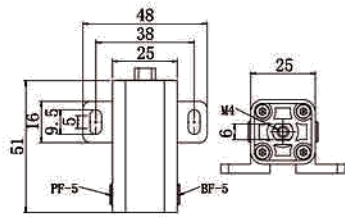

MCD-20大角抱具

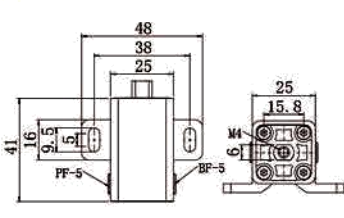

MCD-10椭圆杆抱具

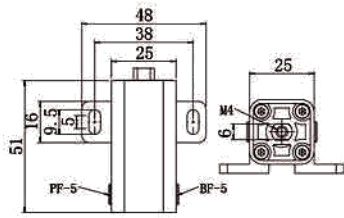

MCD-20椭圆杆抱具

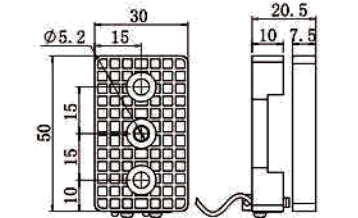

3050椭圆防滑检知抱片

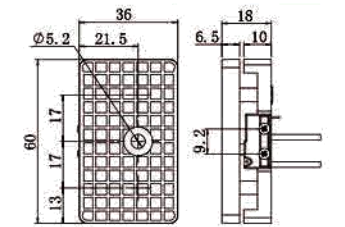

3560检知夹片

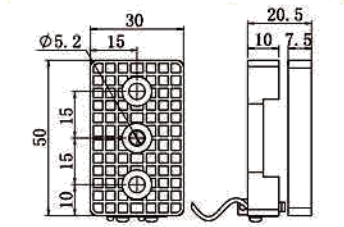

3050椭圆防滑检知抱片

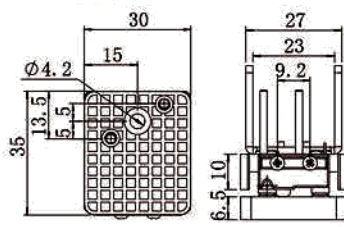

3035检知夹片

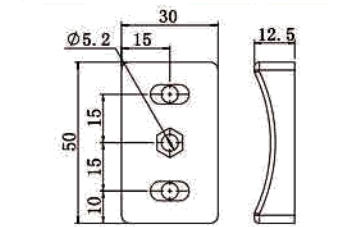

3050半圆光滑夹片

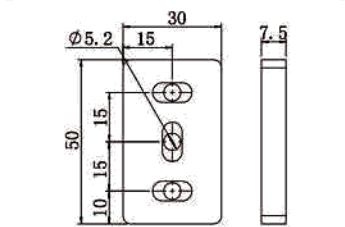

3050平面光滑夹片

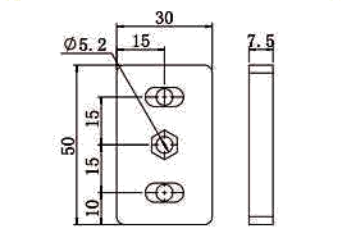

3050平面防滑夹片

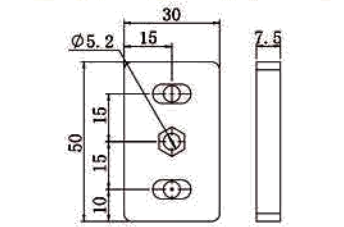

3050N平面防滑夹片

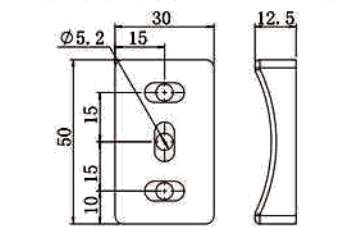

3050弧形光滑夹片



3060S防滑夹片



3035S夹片

夹具系列

○迷你夹具系列

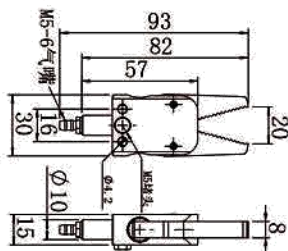

Mini-A内牙

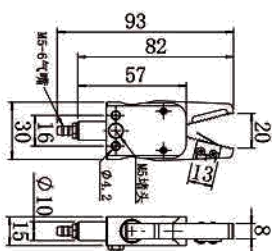

Mini-A内牙带检知

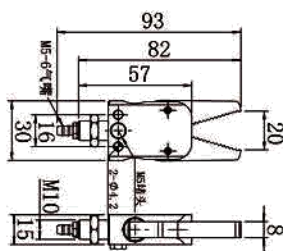

Mini-A外牙

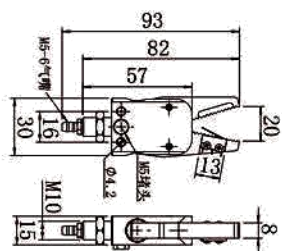

Mini-A外牙带检知

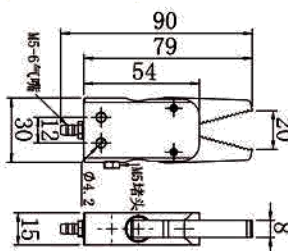

Mini-B

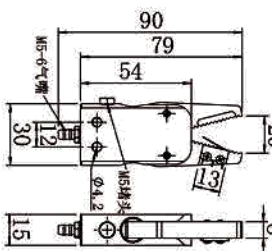

Mini-B带检知

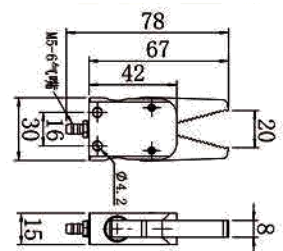

Mini-C

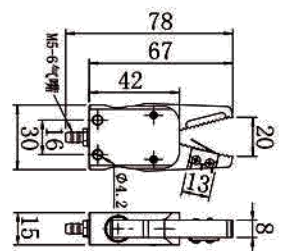

Mini-C带检知

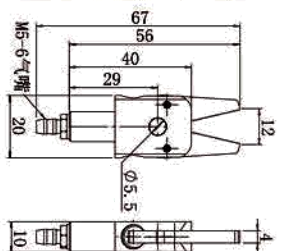

Mini-D内牙

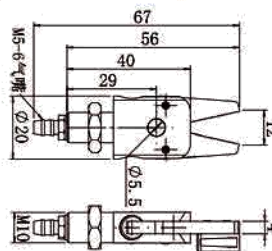

Mini-E外牙

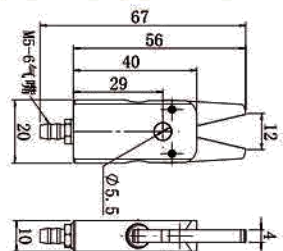

Mini-F

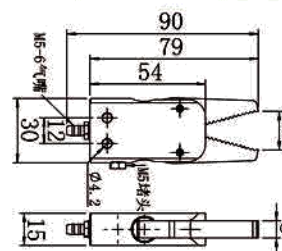

Mini-B升级款

夹具系列

○天行机械手夹具

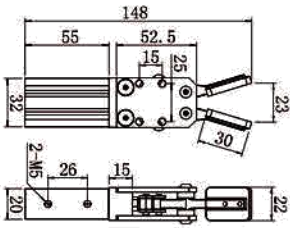

JZ1615D双动

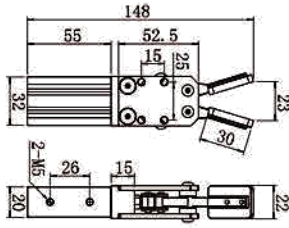

JZ1615S单动

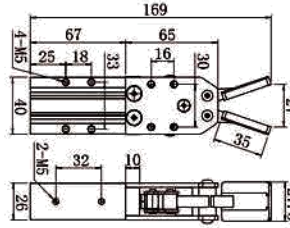

JZ2015D双动

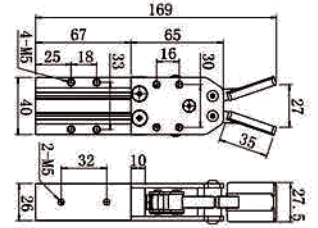

JZ2015S单动

○有信夹具

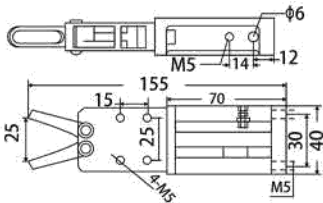

1815S

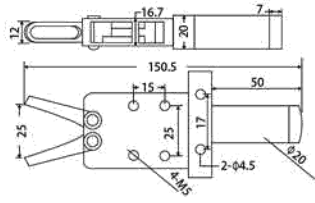
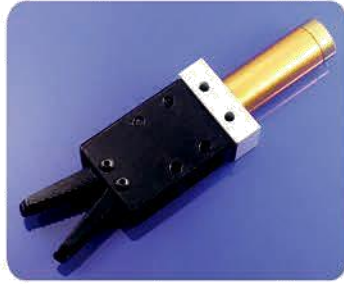

1815S1

○伟立夹具

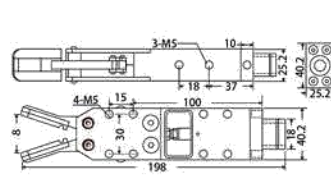

斜臂式

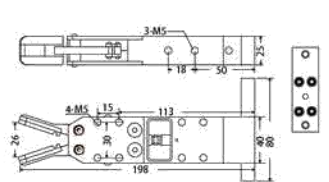
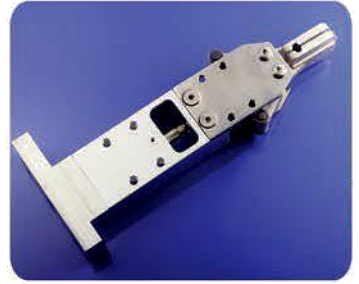

横走式

○哈模机械手夹具

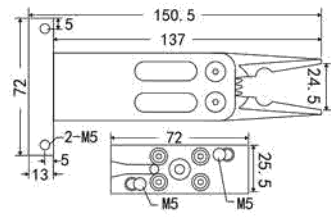

哈模小夹具

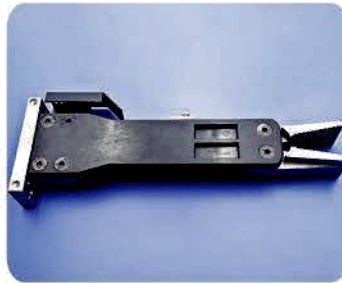

HAMO-D



RCH-16

平行夹具系列 (手指气缸)

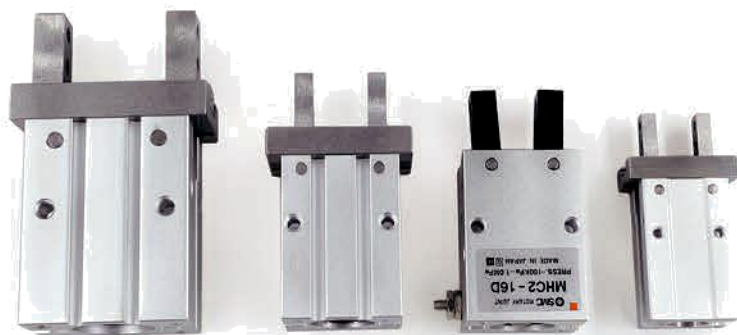

MHZ2-25S MHZ2-16D MHC2-16D MHZ2-10D

外形尺寸图

MHZ2($\phi 10$ — $\phi 40$) 双作用/单作用

基本型

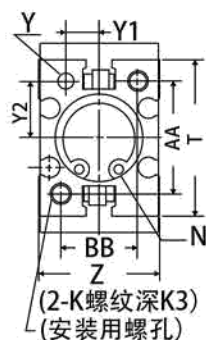
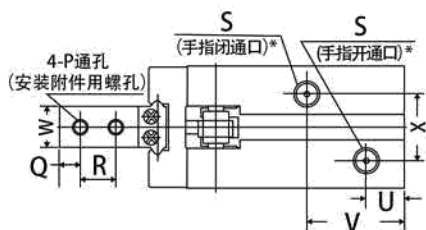
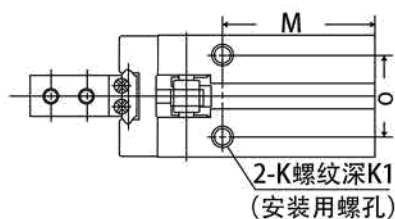
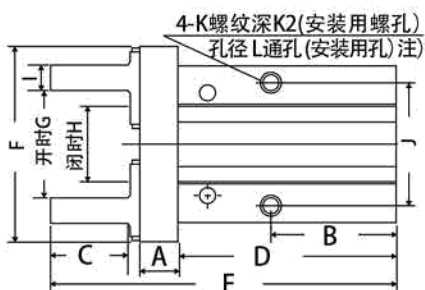

MHZ2-10□ 的磁性开关安装槽尺寸

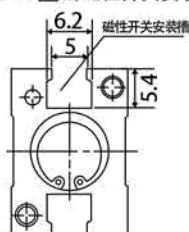

注) 使用磁性开关时, 气缸不可以通孔安装

MHZ2-□□ 的磁性开关安装槽尺寸

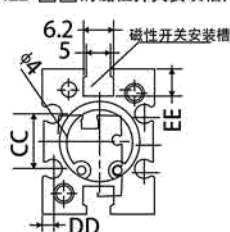

注) 使用磁性开关 D-Y59、D-Y69 及 D-Y77 时, 气缸不可以通孔安装

缸径	V	W	X	Y	Z	Y1	Y2	AA	BB	CC	DD	EE
10	19	$5_{-0.05}^0$	11	$\phi 2H9_{+0}^{+0.025}$ 深3	16.4 ± 0.05	5.2 ± 0.02	7.6 ± 0.02	18	12	---	---	---
16	19	$8_{-0.05}^0$	13	$\phi 3H9_{+0}^{+0.025}$ 深3	23.6 ± 0.05	6.5 ± 0.02	11 ± 0.02	22	15	11.6	2.1	5.8
20	23	$10_{-0.05}^0$	15	$\phi 4H9_{+0}^{+0.03}$ 深4	27.6 ± 0.05	7.5 ± 0.02	16.8 ± 0.02	32	18	14	2.1	9
25	23.5	$12_{-0.05}^0$	20	$\phi 4H9_{+0}^{+0.03}$ 深4	33.6 ± 0.05	10 ± 0.02	21.8 ± 0.02	40	22	19	3.5	11.5
32	31(37)	$15_{-0.05}^0$	24	$\phi 5H9_{+0}^{+0.03}$ 深5	40 ± 0.1	12 ± 0.02	23 ± 0.02	46	26	24	3.3	11.5
40	38(45)	$18_{-0.05}^0$	28	$\phi 5H9_{+0}^{+0.03}$ 深5	48 ± 0.1	14 ± 0.02	29 ± 0.02	56	32	29.4	3.7	13

○平行夹防尘套

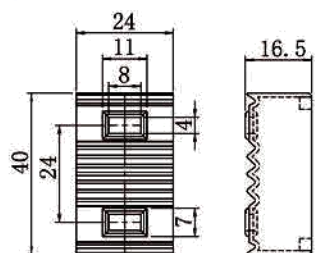

MHZ2-16D/16S防尘套

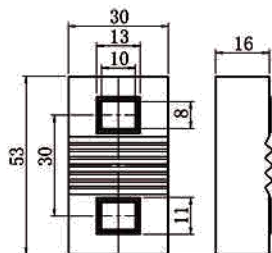

MHZ2-20D/20S防尘套

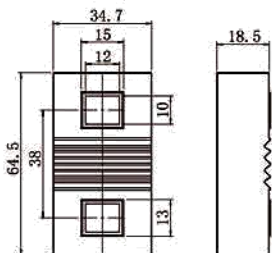

MHZ2-25D/25S防尘套

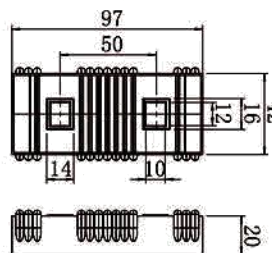

MHZ2-32D/32S防尘套

○星塔(STAR)机械手夹具系列

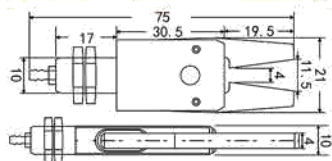

CHK-08-C

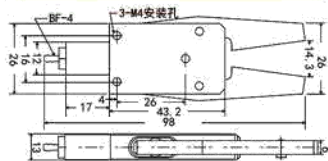

CHK-EMI-12

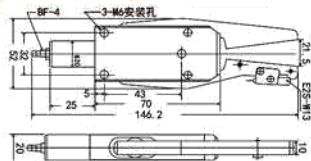

CHK-EX20-D(配线)

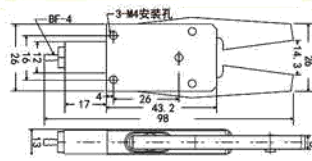

CHK-EMI-12

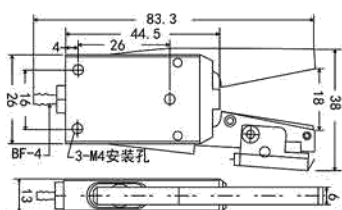

CHK-EM12-C带检知



型号配件齐全 非标可定做



夹具系列

CV真空发生器系列



名称符号说明

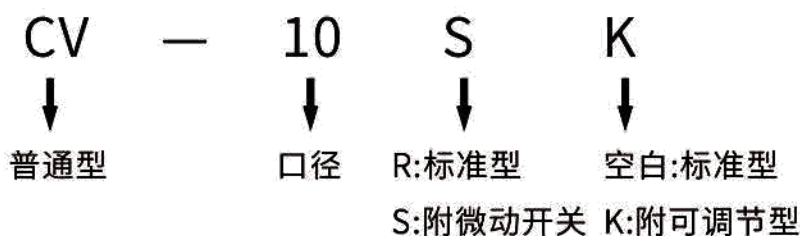

真空发生器产品型号

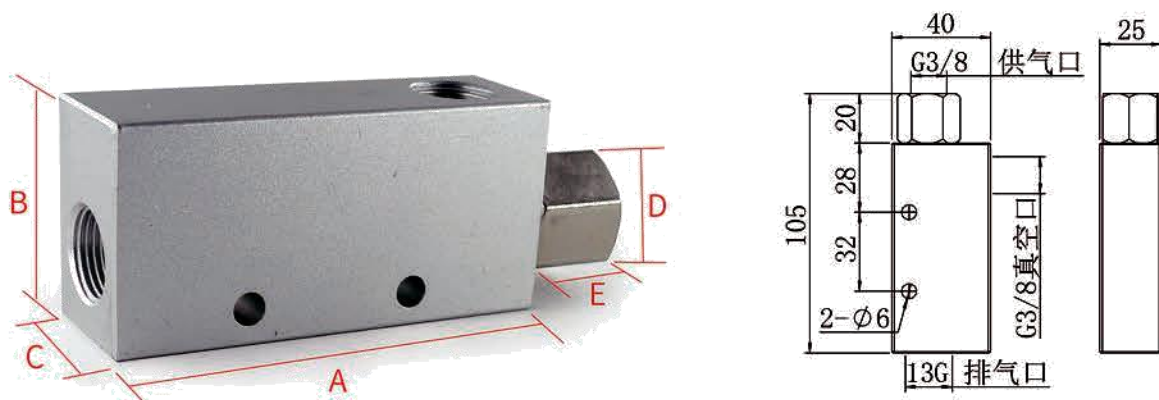

CV-20PT标准型真空发生器

产品型号	A	B	C	D	E	消声器安装螺纹	进气口螺纹	真空口螺纹
CV-10	45	32	16	14	10	G1/8	G1/8	G1/8
CV-15	63	35	20	17	15	G1/4	G1/4	G1/4
CV-20	85	40	25	17	20	G3/8	G3/8	G3/8
CV-25	85	40	25	17	20	G3/8	G3/8	G3/8

真空发生器CV-10HS 侧螺纹内径8MM 进气 出气 排气口均为1分1/8

真空发生器CV-15HS 侧螺纹内径11MM 进气 出气 排气口均为2分1/4

真空发生器CV-20HS 侧螺纹内径15mm 进气口2分1/4 出气口 排气口为3分3/8

真空发生器系列

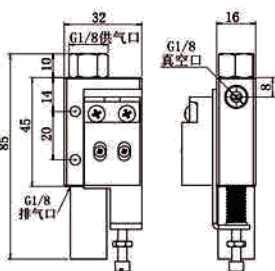
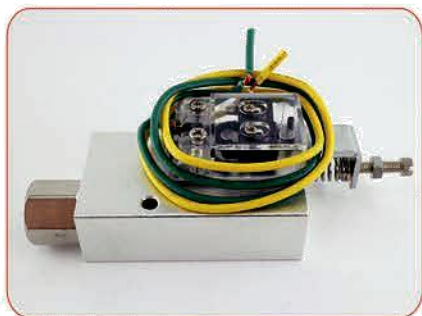

CV-10HSCK带信号开关

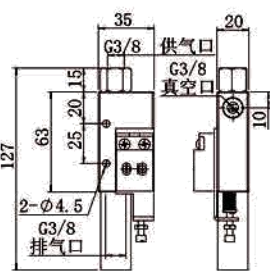

CV-15HSCK带信号开关

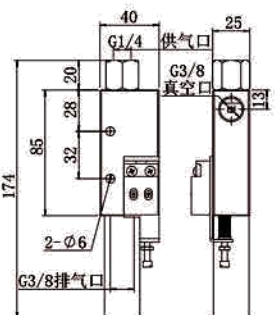

CV-20HSCK带信号开关

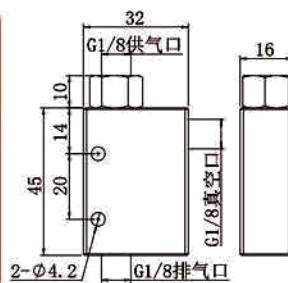

CV-10PT标准型

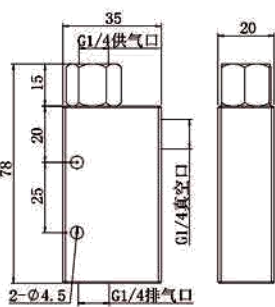

CV-15PT标准型

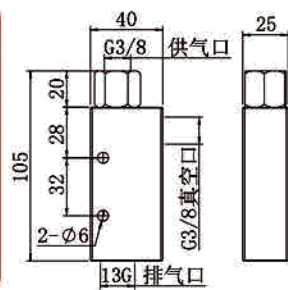

CV-20PT标准型

真空发生器配件系列



1分消声器黑/蓝



2分消声器蓝



2分消声器黑



3分消声器蓝

治具零配件系列

○ 螺母系列

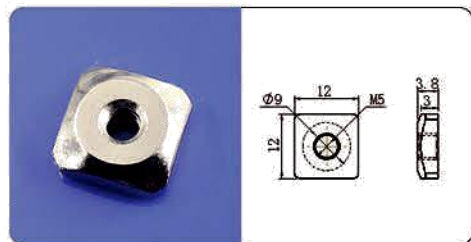

新款单孔螺母M5

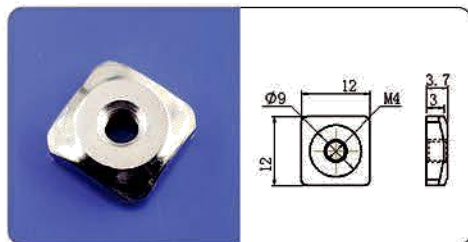

单孔螺母M4

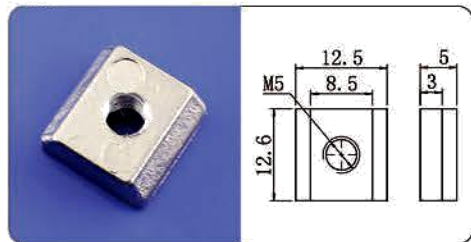

哈模单孔螺母(海尔精锐)

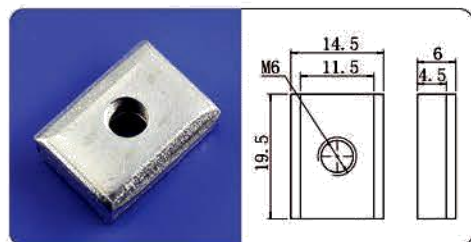

单孔长方形螺母M6

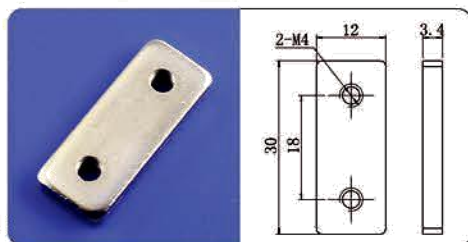

两孔螺母M4

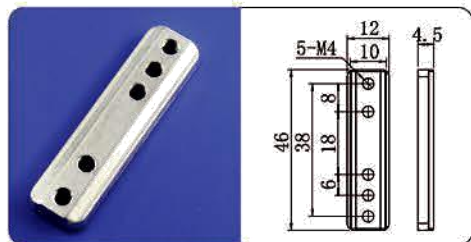

五孔螺母M4

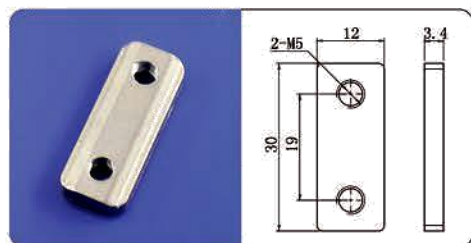

压铸两孔螺母M5

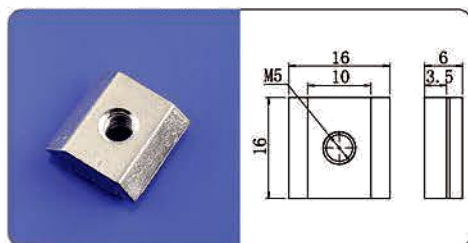

凸形单孔螺母M5

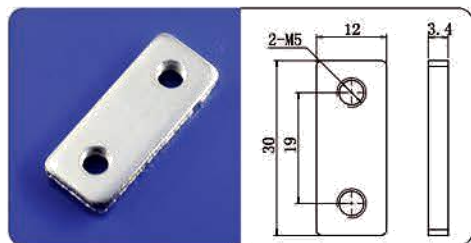

两孔螺母M5

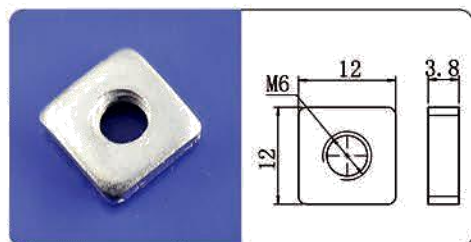

单孔螺母M6

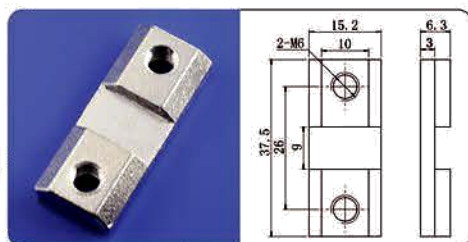

两孔螺母02-M6

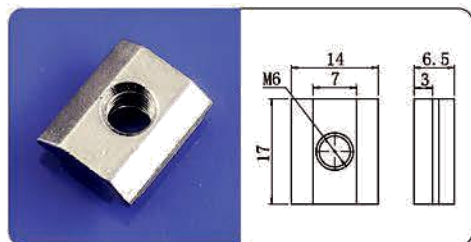

M6凸形单孔螺母

○ 固定块系列

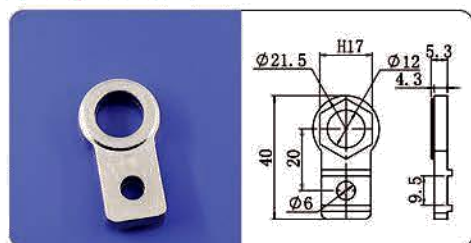

天行金具固定块M12

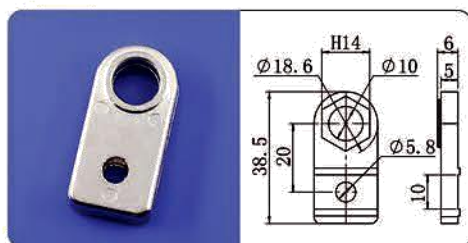

天行金具固定块M10

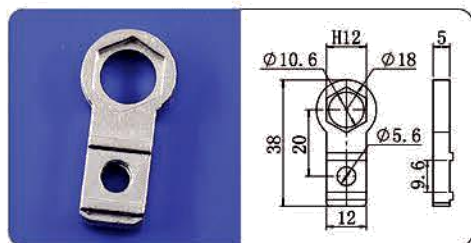

小头M10固定块

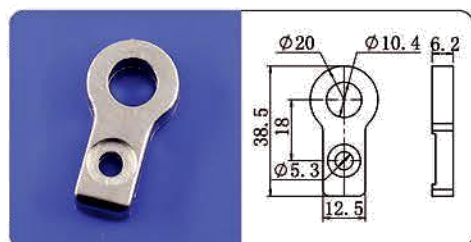

海尔M10

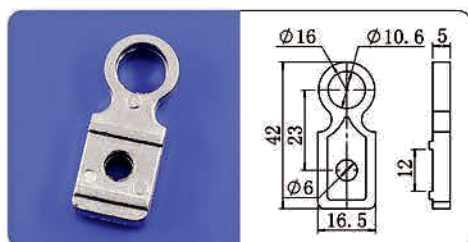

金爪

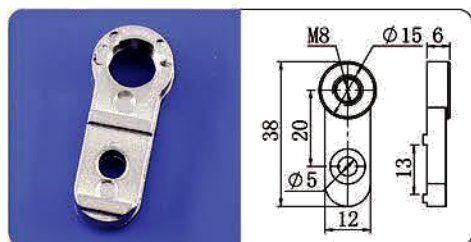

哈模M8

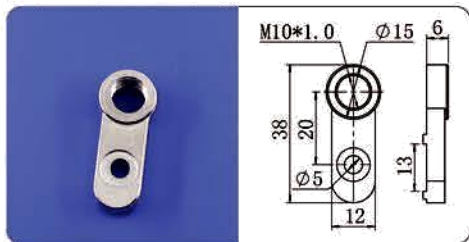

精锐固定块M10

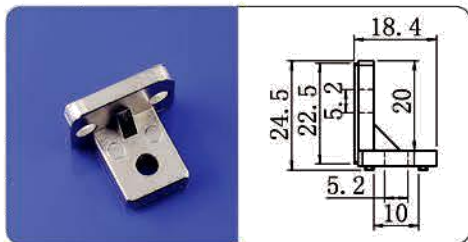

天行L块

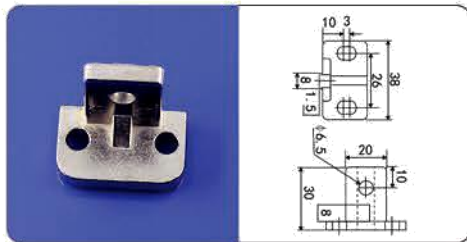

天行治具大L块

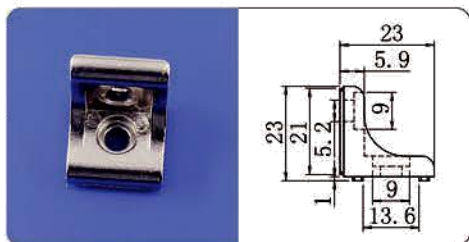

哈模L块

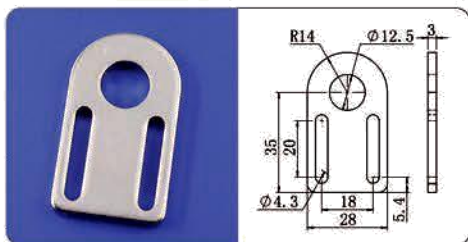

金具固定板A-12.5

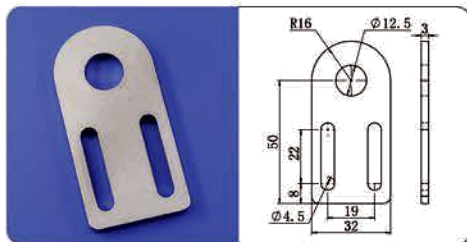

金具固定板B-12.5

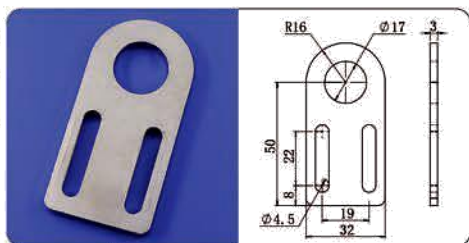

金具固定板B-17



大夹子L固定块

型号齐全 非标可定做

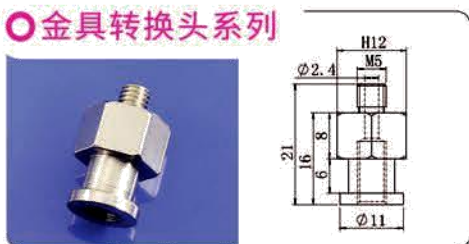

HSPPS-M4外牙M5内牙

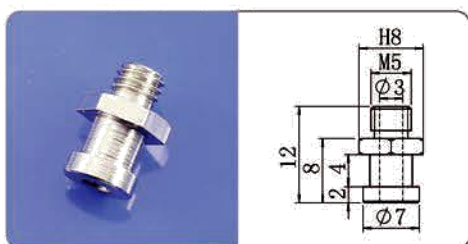

小头金具转换头SPPS-M5

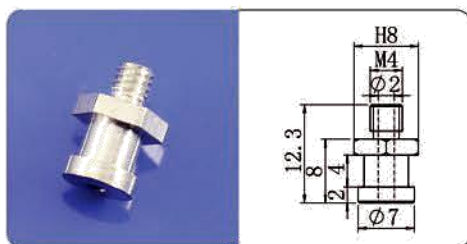

小头金具转换头SPPS-M4

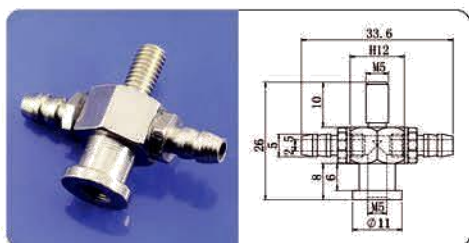

大头M5外牙气缸头

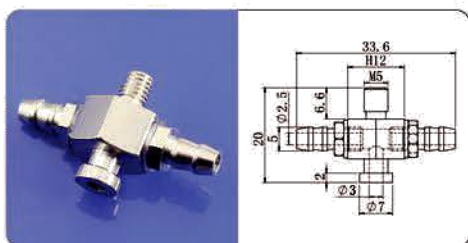

小头气缸头M5外牙

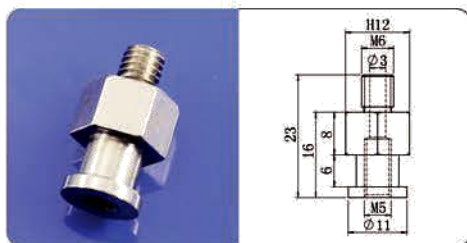

大头金具转换头HSPPS-M6

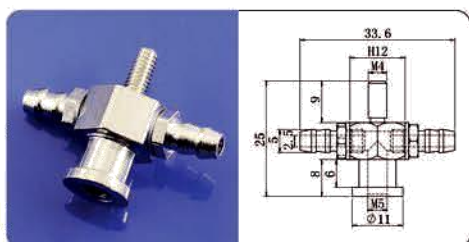

大头气缸转换头M4

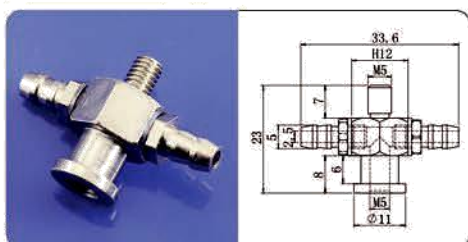

M5气缸头牙短

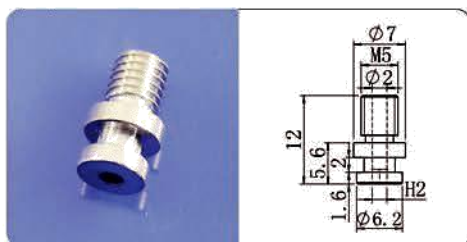

转换头P6M5N

治具零配件

金具转换头系列

○ 转换头 气咀 气排系列

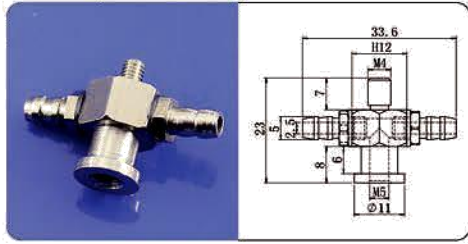

大头气缸头M4牙短

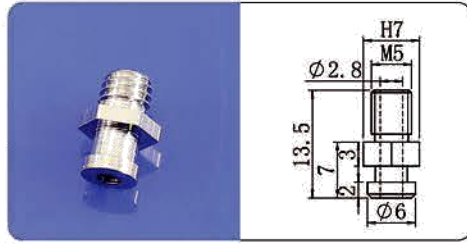

M5微型金具PS专用

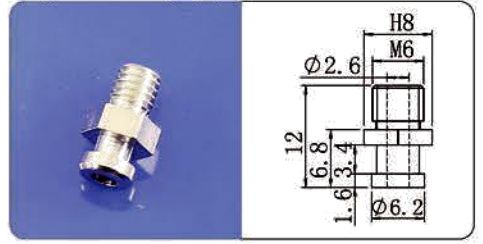

小头金具转换头M6

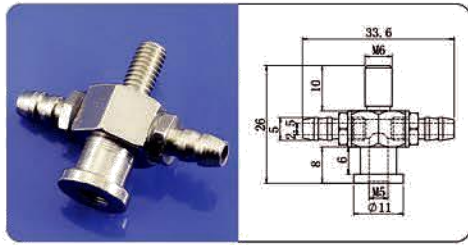

M6气缸头长牙

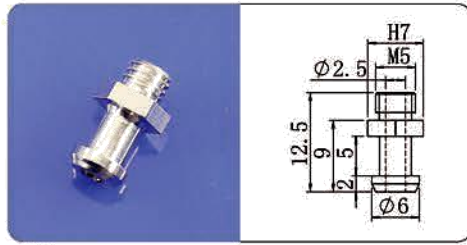

SPPS-M5 B

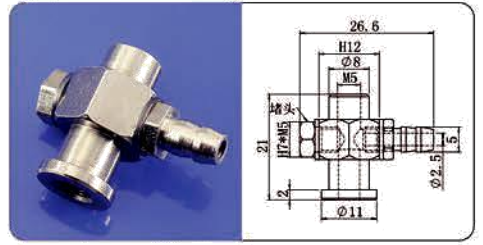

M5内牙气缸头(单侧通)

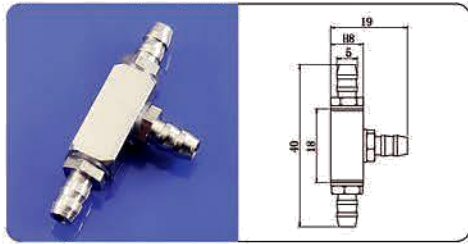

三通气咀转换头

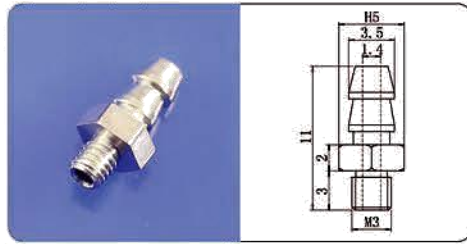

M3-4二节气咀

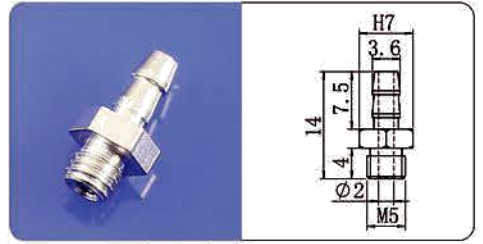

M5-4二节气咀

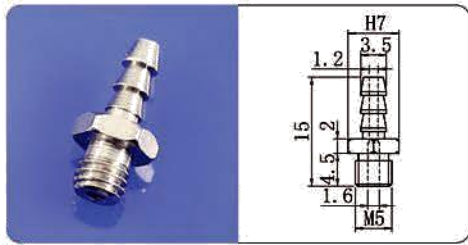

M5-4三节气咀

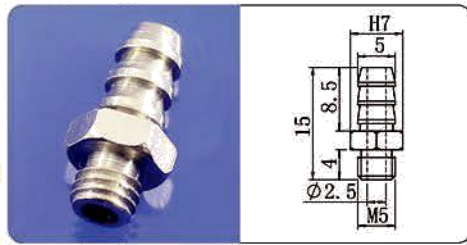

M6-3三节气咀

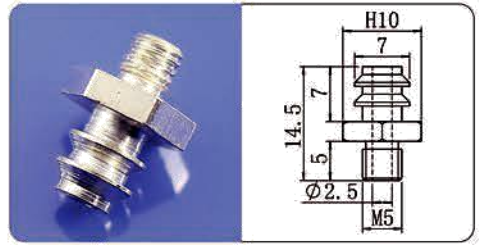

M5-7二节气咀

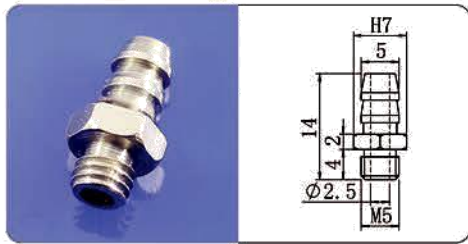

M5-6二节气咀

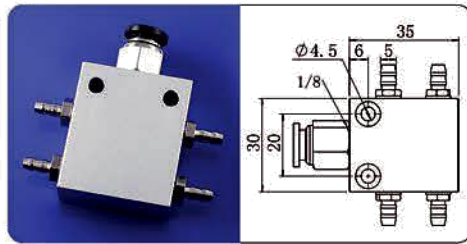

1分4气排

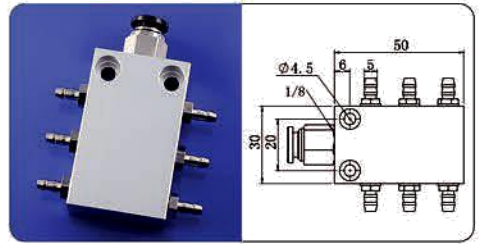

1分6气排

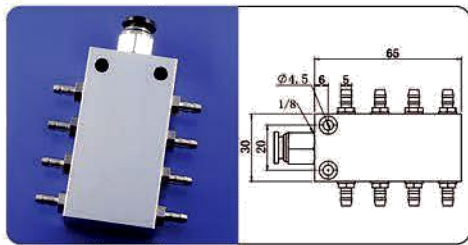

1分8气排

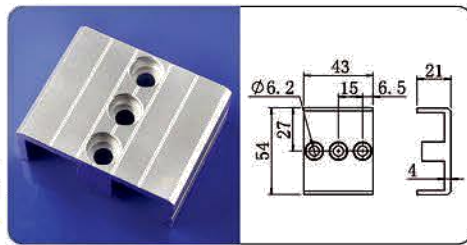

双槽通孔铝条固定块

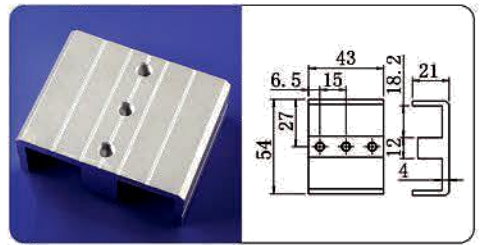

双槽通孔有牙M5铝条固定块

治具铝条固定块系列

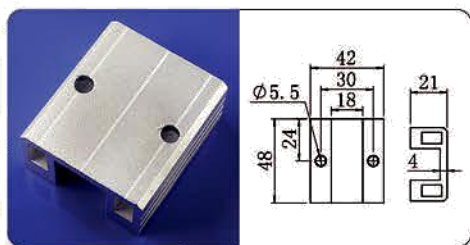

单槽通孔固定块

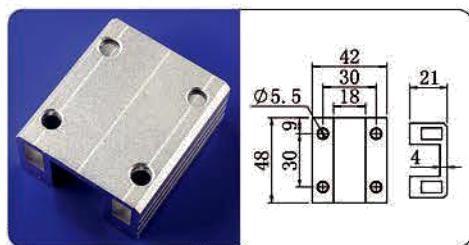

单槽通孔(四个孔)

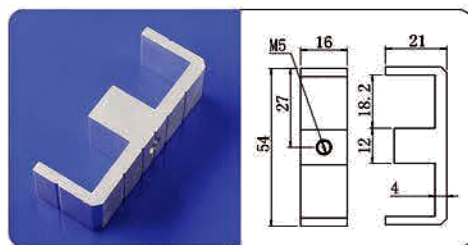

双槽单孔

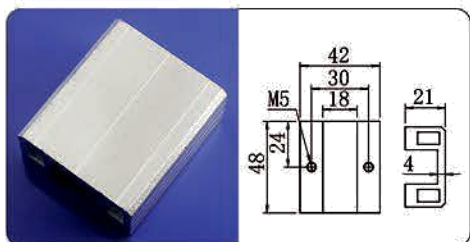

单槽M5不通孔

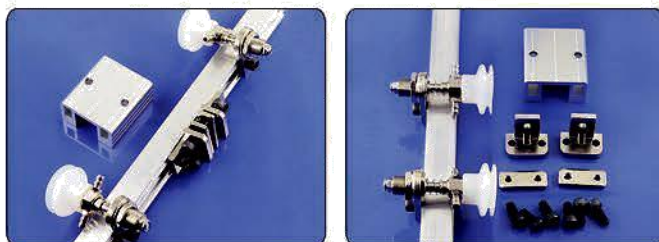

铝条固定块配件

气动接头系列

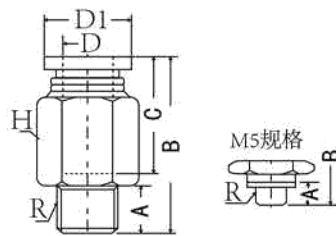

型号	D	D1	R	A	B	H	C
PC6-01	6	12	1/8	6.5	20	12	14
PC4-M5	4	11	M5*0.8	4	20.2	10	15
PC6-M5	6	12	M5*0.8	3.5	19.2	12	15.5
PC8-M5	8	14-16	M5*0.8	4	25.5	14	20.5

型号齐全 坚固耐用



PC8-01黑色/蓝色



PC8-M5蓝色 PC8-01



PC8-01 PC6-01 PC6-M5 PC4-M5

气管接头系列

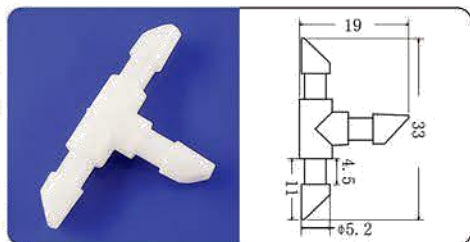

无牙塑料三通接头#6

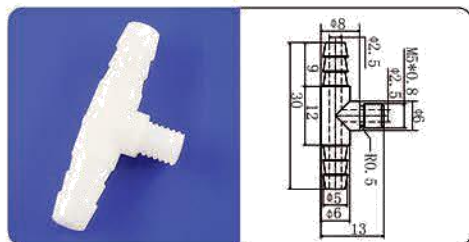

有牙塑料三通接头M5

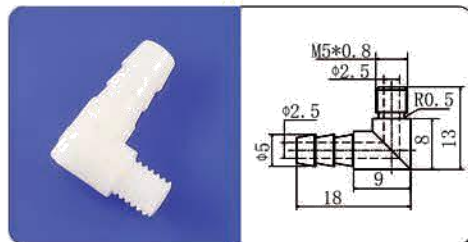

有牙塑料弯头M5

○ 螺钉系列



○ 铝型材系列

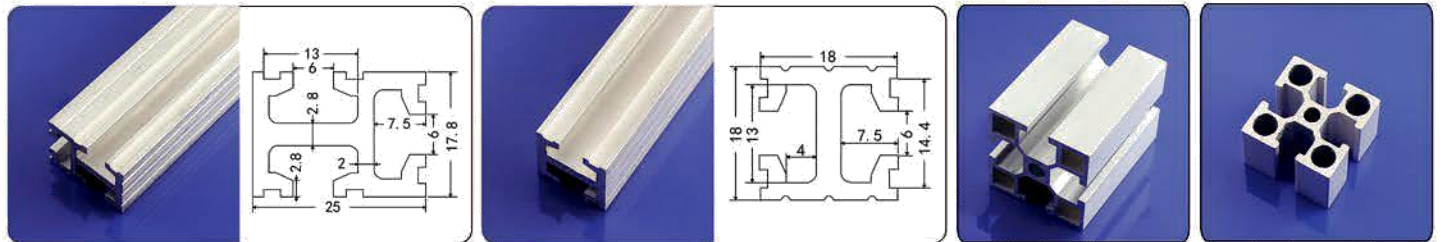
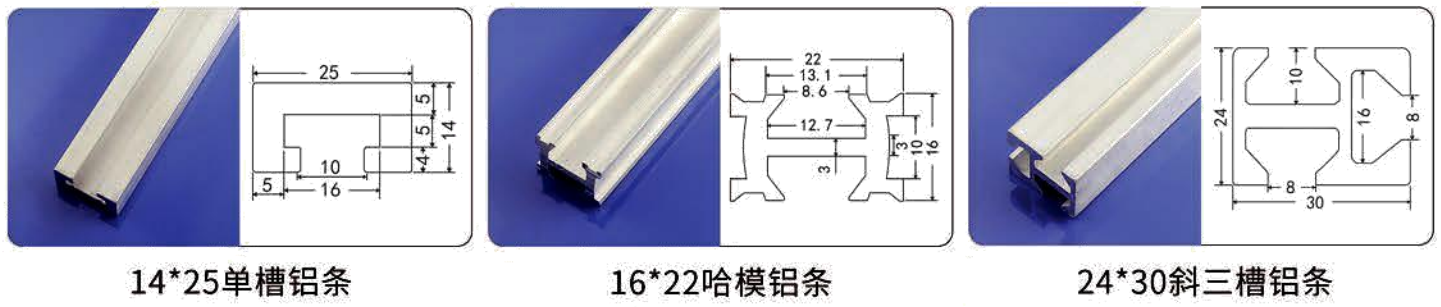

○ SMC快速接头 18*25三槽铝条 18*18天行铝条 GYL-4040E 其他型号可定做

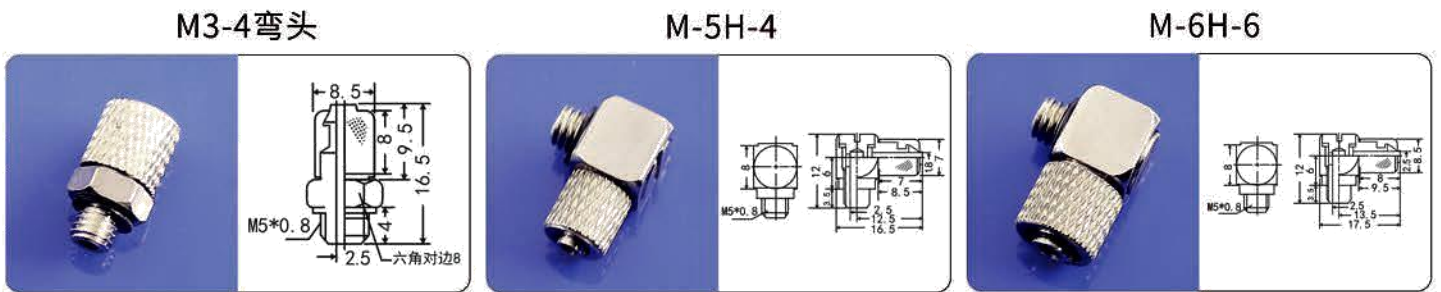
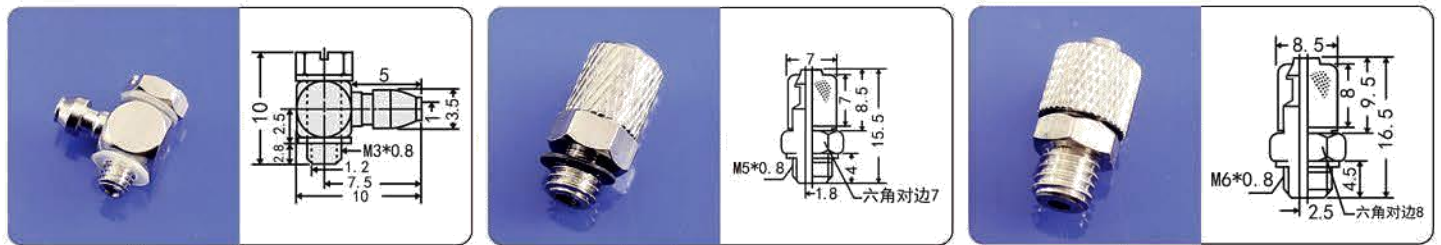

治具零配件

○真空吸盘压环系列

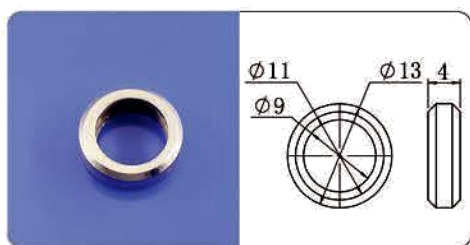

小环 ϕ 13

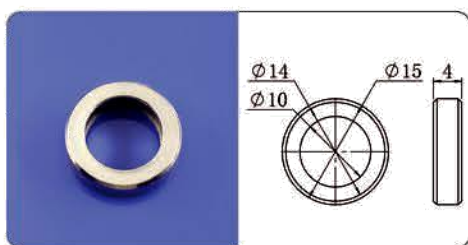

中环 ϕ 15

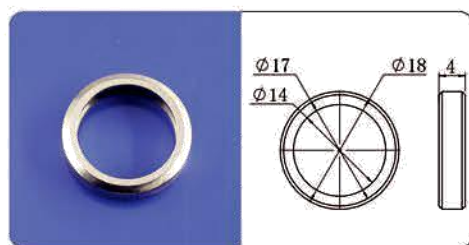

大环 ϕ 18

○硅胶管系列



2*4



3*6



耐高压PU管4*6



耐高压PU管5*8

○磁性开关系列



AN-11R-01



D-A93



AN-20R(PAB-01)



AN-03R(PB0-01)



AN-36R-02



AN-06R



AN-07R



AN-07D

